

USER MANUAL NXA



acoem

CONTENT

Welcome to our world	1.1	Max Min ROP	19.1
Declaration of Conformity	2.1	Text Editor	20.1
Safety	3.1	Machine Defined Data	21.1
Care	4.1	Repeatability Test	22.1
Main Menu	5.1	Tolerance Table	23.1
Shaft Alignment	6.1	Memory Manager	24.1
Horizontal Machines		Global Settings	25.1
Shaft Alignment	7.1	Display Unit NXA D	26.1
Vertical Machines		Sensors M3 and S3	27.1
Shaft Alignment Offset Machines	8.1	Run-Out Probe PI	28.1
Machine Train Alignment	9.1	Level Sensor LI	29.1
Softcheck	10.1	Technical Specification NXA D	30.1
Softcheck ROP	11.1	Technical Specification	31.1
Target Values	12.1	M3 and S3	
OL2R	13.1	Technical Specification PI	32.1
Hot Check	14.1	Technical Specification LI	33.1
Target Values Clock	15.1		
Sensor Display	16.1		
Sensor Display Level	17.1		
Sensor Display ROP	18.1		

WELCOME TO OUR WORLD

Since the very beginning in 1984, ACOEM AB (formerly known as ELOS Fixturlaser AB) has helped industries throughout the world to achieve more profitable and sustainable production. We have reached where we are today by having the courage to think beyond the norm and follow slightly unconventional paths. We have had the courage to make mistakes and find new directions. Through our resolve, ambition and knowledge we have become a global player and a leader in innovative, user-friendly shaft alignment.

SUSTAINABLE INNOVATIONS

During our almost 30 years in this industry, we have explored, tweaked and tested more than anyone. Some might say we are incurable innovators whereas others might

say that we are highly focused. They both probably have a point. If we had not been devoted and ambitious, we would not have been the first in the industry to have a touch screen. Nor would we have been pioneers in the use of visible lasers and dual measurement heads.

Over the years, we have learnt to never compromise on quality, and we are constantly in search of new, unexplored opportunities by combining advanced technology with design and function. By doing so, we have become the leading innovator in our industry. Not only do we minimize wear, production stoppages and costs, we also help save the environment. Natural resources are in short supply and if we can contribute to a more sustainable

world by making it a little bit straighter, we couldn't be happier.

TRUE COMMITMENT

One reason for our success is our solid commitment. We have ensured that we remain attentive to constantly pick up on the needs of the market. Our expert employees and dedicated dealers in over 70 countries are undoubtedly our most important asset. Satisfaction and team spirit are of particular importance to us and are consistently at the top of our priority list. With experience from a wide range of industries and manufacturing processes, we are fully aware of the problems and needs of our end-customers. We are passionate about what we do, and we are driven by the desire to eliminate anything in the industry

worldwide that may be even slightly out of line.

PURE USABILITY

Our design and user-friendliness are carefully interwoven. As we develop new products, they also become cleaner, smarter, more functional and more robust. An industrial environment is demanding, infinitely more difficult to work in and inevitably subject to time pressure. There is no place for equipment with unnecessary functions, complicated interfaces and that is difficult to assemble.

Usability and user friendliness mean everything, not only to us but also to our customers. We have designed products that are easy to learn and can be incorporated quickly. By removing non-essential functions,

we make life less difficult for our users – and probably a little more difficult for our competitors.

END USER LICENSE AGREEMENT

The rights to use the software in this product are offered only on the conditions that you agree to all the terms stated below, i.e. the end user agreement. By using this product, you agree to be bound by this agreement. If you do not accept this agreement your sole remedy is to return the entire unused product, hardware and software, promptly to your place of purchase for a refund.

The user is granted a single license to use the software contained in this product. Use is only permitted on the hardware it has been installed on at the time of purchase. The software may not be removed from the hardware.

The software contained in the system is the property of ACOEM AB, any copying or redistribution is strictly prohibited.

Modifying, disassembling, reverse engineering or decompiling the system or any part thereof is strictly prohibited.

Disclaimer of warranties: To the maximum extent permitted by applicable law, ACOEM AB and its suppliers provide the software contained in this product 'as is' and with all faults, and hereby disclaim all other warranties either expressed, implied or statutory.

Limited liability: No liability shall exceed the price of the product, and the sole remedy, if any, to any claim shall be a right of return and refund.

ACOEM AB or its suppliers shall, to the maximum extent permitted by applicable law, not be liable to any indirect, special, incidental, punitive, and consequential damages arising from the use of the system or any part thereof, authorized or unauthorized.

ACOEM AB (formerly known as Elos Fixturlaser AB) is since mid-2014 a fully owned subsidiary of ACOEM Group, headquartered in Lyon, France. For more information please visit www.acoem.com

DECLARATION OF CONFORMITY

In accordance with
2014/35/EU Low Voltage Directive
2014/53/EU Radio Equipment Directive
2012/19/EC Waste electrical and electronic equipment (WEEE)
2011/65/EU Restriction of the use of certain hazardous substances (RoHS)
2006/66/EU Battery Directive
2001/95/EC CE marking directive

Type of equipment

Alignment System

Brand name or trade mark

NXA

Type designation(s)/Model no(s)

I-0912 NXA D

I-0913 M3

I-0914 S3

I-1063 PI

I-1066 LI

Manufacturer's name, address, telephone & fax no

ACOEM AB

Box 7

SE-431 21 Mölndal

Sweden

Tel: +46 31 7062800

Fax: +46 31 7062850

The following standards and/or technical specifications, which comply with good engineering practice in safety matters in force within the EEA, have been applied:

Standard/Test report/Technical construction file/Normative document

EN 61000-6-3:2007.

EN 61000-6-2:2005, EN 61000-4-2, -3, -4, -5, -6, -11.

EN 61010-1:2010

ISO9001:2015 Ref. No/ Issued by: DNV Certification AB Certification No. 2009-SKM-AQ-2704/2009-SKM-AE-1419.

The laser is classified in accordance with the International Standard IEC-60825-1:2014, USA FDA Standard 21 CFR, Ch 1, Part 1040.10 and 1040.11 except for deviations pursuant to laser notice No. 50, dated June 24, 2007.

The wireless device complies with Part 15 of the FCC Rules. Operation is subject to the following two conditions:

(1) this device may not cause harmful interference, and

(2) this device must accept any interference received, including interference that may cause undesired operation.

Additional information

The product was CE-marked in 2013.

As manufacturer, we declare under our sole responsibility that the equipment follows the provisions of the Directives stated above.

Date and place of issue

Mölnådal 2020-01-10

Signature of authorized personA handwritten signature in black ink, appearing to read 'Hans Svensson', written in a cursive style.

Hans Svensson, Managing Director

SAFETY

Retain and follow all product safety and operating instructions. Observe all warnings on the product and in the operating instructions.

Failure to observe the safety pre-cautions and operating instructions can cause bodily injury, fire, and damage to the equipment.

Do not disassemble, modify or use the equipment in other ways than explained in the operating instructions. ACOEM AB will not accept any liability for such use.



WARNING!

Do not mount equipment on running machines and take all appropriate measures to prevent unintentional start-up of machines. Make sure to fully comply with all appropriate shut down procedures, safety measures and regulations at worksite and local regulations regarding safety in a machine environment.

LASER PRECAUTIONS

NXA uses laser diodes with a power output of < 1.0 mW. The laser classification is Class 2.

Class 2 is considered safe for its intended use with only minor precautions required. These are:

- Never stare directly into the laser transmitter.
- Never shine the laser directly into anyone else's eyes.



COMPLIES WITH 21 CFR 1040.10 AND 1040.11
EXCEPT FOR DEVIATIONS PURSUANT TO
LASER NOTICE No. 50, DATED JUNE 24, 2007



CAUTION!

USE OF CONTROLS OR ADJUSTMENTS OR PERFORMANCE OF PROCEDURES OTHER THAN THOSE SPECIFIED HEREIN MAY RESULT IN HAZARDOUS RADIATION EXPOSURE.

Your system complies with the requirements in:

- IEC-60825-1:2007
- British Standard BS EN 60825-1
- DIN EN 60825-1

USA FDA Standard 21 CFR, Ch I, Part 1040.10 and 1040.11

POWER SUPPLY

NXA is powered by high-capacity rechargeable Li-Ion batteries mounted in the display unit and the sensors or by the external power units.



Both the display unit and the sensors (M3 and S3) can be connected to their chargers and charged while lying in the case. It is important that the lid of the case is open during the charging and that the chargers are placed outside the case or else the system will not be charged properly and might be damaged.

Do not expose the power adapters to rain or wet conditions.

Always unplug the chargers from the electrical outlet after charging.

Leaving a display unit or a measurement unit with an empty battery for a prolonged time can reduce the capacity of the battery or even damage the battery.

If the system is not used for a long time, charge the batteries to approximately 50-75% before storing the system, if kept in storage repeat this every 3-4 month (if needed).

When used in typical conditions the battery will sustain good capacity for approximately 2-3 years before needing replacement. Contact your sales representative for battery replacement.

The batteries contain safety circuitry to operate safely with the display unit. The unit can therefore only be used with the Li-Ion batteries supplied by ACOEM.

Improper replacement of batteries can cause damage and risk for personal injury.



WARNING!

BATTERY REPLACEMENT SHALL ONLY BE PERFORMED BY AUTHORIZED ACOEM REPRESENTATIVES.

USE OF ANY OTHER BATTERIES THAN THOSE SUPPLIED BY ACOEM WILL CAUSE SEVERE DAMAGE TO THE DISPLAY UNIT AND CAN CAUSE RISK FOR PERSONAL INJURY!

Handle any batteries with care. Batteries pose a burn hazard if handled improperly. Do not disassemble and keep away from heat sources. Handle damaged or leaking batteries with extreme care. Please keep in mind that batteries can harm the environment. Dispose of batteries in accordance with local regulatory guidelines, if in doubt contact your local sales representative.

Only use the external power adapters supplied by ACOEM for use with the Display Unit and the sensors. Using other power adapters can cause damage to the unit and personal injury.

WIRELESS TRANSCEIVER

The NXA system is fitted with a Bluetooth wireless transceiver.

Make sure that there are no restrictions on the use of radio transceivers at the site of operation before using the wireless transceivers.

Please refer to the chapter “Global settings” on how to turn off the Bluetooth transmitters for use in restricted environments.



WARNING!

Before using the wireless transceivers make sure that there are no restrictions on the use of radio transceivers at the site. Do not use on aircraft.

CLEANING

The system should be cleaned with a cotton cloth or a cotton bud moistened with a mild soap solution, except for the detector and laser window surfaces, which should be cleaned with alcohol.



For the best possible function, the laser diode apertures, detector surfaces and connector terminals should be kept free from grease or dirt. The display unit should be kept clean and the screen surface protected from scratches.



Do not use paper tissue, which can scratch the detector surface.



Do not use acetone.

The chains on the V-block fixtures are delivered dry. If the system is used in highly corrosive environments, the chains should be oiled.

DATE OF CALIBRATION DISCREPANCY

Our instruments store the electronic date of the latest calibration of the instrument. Due to production processes and storage time, this date will differ from the date of the calibration certificate. Hence, it is the date of the calibration certificate which is important and that indicates when the next calibration is due.

MAIN MENU

The NXA is available with different programs for specific purposes. The programs included depend upon which application packages and accessories you have selected.



Press the ON button to start the system and the Main Menu appears.



In the Main Menu, you can select the program that you want to use.

In the Main Menu, you will also find the Memory Manager and Global Settings.

APPLICATION PROGRAMS



Shaft Alignment Horizontal
Machines



Shaft Alignment Vertical
Machines



Shaft Alignment Offset
Machines



Machine Train Alignment



Softcheck



Softcheck ROP



Target Values



OL2R



Hot Check



Target Values Clock



Sensor Display



Sensor Display Level



Sensor Display ROP



Max Min ROP



Text Editor



Machine Defined Data

MEMORY MANAGER



Memory Manager

SYSTEM FUNCTIONS



Global Settings



Bluetooth Indicator



Backlight



Battery Status



Off



SHAFT ALIGNMENT HORIZONTAL MACHINES

INTRODUCTION

Shaft alignment: Determine and adjust the relative position of two machines that are connected, such as a motor and a pump, so that the rotational centers of the shafts are collinear, when the machines are working in a normal operating condition. Correction of horizontal shaft alignment is done by moving the front and the rear pair of one machine's feet, vertically and horizontally, until the shafts are aligned within the given tolerances. A tolerance table is available in the system.

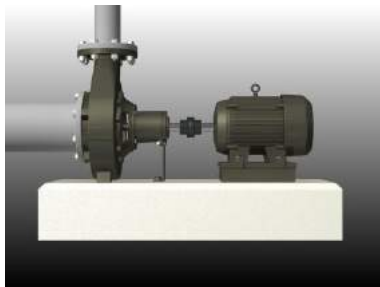

The NXA system has two measuring units that are placed on each shaft by using the fixtures supplied with the system.



Adjustment of the machine can be made directly, according to the displayed values.

The alignment results can be saved in the memory manager. The measurements in the memory manager can easily be transferred to a PC for further documentation purposes.

After rotating the shafts into different measuring positions, the system calculates the relative distance between the two shafts in two planes. The distances between the two measuring planes, distance to the coupling and distances to the machine feet are entered into the system. The display box then shows the actual alignment condition together with the position of the feet.

PRE-ALIGNMENT FUNCTIONS

To obtain the best possible conditions for shaft alignment, it is necessary to perform some pre-alignment checks. In many cases it is necessary to make these checks in order to obtain precise alignment. It is often impossible to reach the desired alignment results if you do not make any pre-alignment checks.

Before going on site, check the following:

- What are the required tolerances?
- Any offsets for dynamic movements?
- Are there any restrictions for mounting the measuring system?
- Is it possible to rotate the shafts?
- What shim size is needed?

Before setting up the alignment system on the machine, check the machine foundation, bolt and shim condition. Also check if there are any restrictions in adjusting the machine (if e.g. there is enough space to move the machine).

After the visual checks have been performed, there are some conditions that must be considered:

- Check that the machine has the right temperature for alignment.
- Take away old rusty shims (check that you can remove shims).
- Check coupling assembly and loosen the coupling bolts.
- Check soft foot conditions.

- Mechanical looseness.
- Check coupling and shaft run-out.
- Pipe work strain.
- Coarse alignment.
- Check coupling gap (axial alignment).

MOUNTING

The sensor marked "M" should be mounted on the movable machine and the sensor marked "S" on the stationary machine. The sensors shall be assembled on their V-block fixture and placed on each side of the coupling.

Hold the V-block fixture upright and mount it on the shafts of the measurement object.



Lift the open end of the chain, tension it so that the slack is removed and attach it to the hook.



Firmly tighten the chain with the tensioning screw. Use the supplied tensioning tool. Do not over-tighten. If the shaft diameter is too large the chains can be extended with extension chains.



Adjust the height of the sensor by sliding it on the posts until a line of sight is obtained for both lasers. Secure its position by locking both clamping devices on the back of both units



The laser of the M-sensor can be adjusted with the adjustment screw on the top of the unit. There is normally no need to adjust the laser, but this might be necessary when measuring at long distances.

NOTE: Make sure that the adjustment screw is secured with the locking nut after adjustment.

MEASUREMENT METHODS

In the Horizontal Shaft Alignment program, there are three different measurement methods, the Express Mode method, the Tripoint method and the Clock method. Select the measurement method in Settings.



Express Mode™ method

In the Express Mode method, the alignment condition can be calculated by recording three points while rotating the shafts at least 60° . After recording the 1st point, the other points are taken automatically when the shafts are rotated to a new position and are kept in position for more than 2 seconds.



Tripoint™ method

In the Tripoint method, the alignment condition can be calculated by taking three points while rotating the shaft at least 60° . In this method, all points are taken manually.



Clock method

In the Clock method, machinery positions are calculated by taking three points with 180° of rotation. The Clock method is useful when comparing the measurement results with traditional alignment methods using dial gauges and reversed rim method. The method can also be used when the machines are standing on non-horizontal foundations or when the shafts are not coupled.

STARTING THE PROGRAM



Start the program by touching the Horizontal Shaft Alignment icon in the Main Menu.



Go to Settings for selecting measurement method and other settings.



Go to Configuration to configure the measurement.

SETTINGS



These settings are unique for this application.

For most of the settings, the current selection is shown in the icon.

The functions that are available depend upon which application packages and accessories you have selected.

Measurement method



Opens window for selection of measurement method. Express Mode, Tripoint or the Clock method.

HyperMode



Opens window for activating or deactivating HyperMode.

Resolution shown



Opens window for selection of resolution shown.

Resolution shown depends also on connected receiver.

Sampling time



Opens window for selection of sampling time.

A repeatability test can also be made here. See chapter "Repeatability test".

Adjustable screen filter



Opens window for activating or deactivating the adjustable screen filter.

Note: The adjustable screen filter should be deactivated for normal operation, and only activated in environments with severe vibrations.

OmniView activation



Opens window for activating or deactivating OmniView.

Extended Alignment



Opens window for activating or deactivating extended alignment.

Sensor Display



Starts Sensor Display. See chapter "Sensor Display".

Global settings



Opens Global settings. See chapter "Global settings".

Confirm



Exits the Settings and returns to the application.

CONFIGURATION

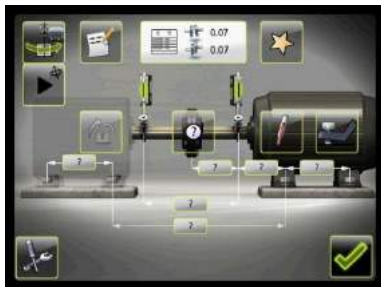

Dimensions



Tolerance table



Opens the tolerance table. See chapter "Tolerance table".

Coupling type



Opens window for selection of coupling type. Normal coupling, coupling gap or spacer shaft.

Notes



Opens Notes, where notes can be entered.

Target values



Opens Target values. See chapter "Target values".

Softcheck™



Starts Softcheck. See chapter "Softcheck".

Add new machine with defined data



Opens window for adding a new machine with defined data to Machine Defined Data.

Entered data, such as distances, Target Values and tolerances, will be saved.

Feet Lock



Opens Feet Lock.

OmniView synchronization



Synchronizes OmniView.

Screen Flip



Screen Flip.

Settings



Goes to Settings.

Confirm



Exits the configuration and returns to the application.



EXPRESS MODE™ METHOD

Select the Express Mode method in Settings.

NOTE: The shafts should be coupled during measurement in order to achieve as reliable and accurate results as possible, when using the Express Mode method.

TIP: The larger the angle over which the three points are measured, the fewer moves, and repeat measurements will have to be made. Minimum angle between readings is 30° (60° if the distance between the sensors is less than 200 mm).

Enter dimensions

The screen displays the movable machine. The traffic lights show green when the laser hits the detector.



Starts sequence for entering dimensions and tolerance.

Measure and enter dimensions and tolerance.

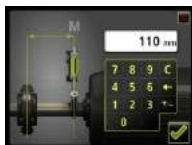

entered now or later (these distances are necessary to provide the feet values).

You must enter the distance between the sensors, and the distance between the center of the coupling and the M-sensor. (If you only wish to check shaft alignment, these are the only necessary distances).



The distance between the M-sensor and the first pair of feet and the distance between the first and the second pairs of feet can be

Measurement point registration

Set the sensors so that they are at approximately the same rotational angle.



Touch the register icon.

This starts the measurement point registration and registers the first reading.

The first position can be registered automatically, if the shafts first are rotated counterclockwise more than 3° between 6 o'clock and 12 o'clock and then clockwise more than 3° .

The reading is then taken automatically when the sensors have been stationary for 2 seconds.



Rotate the shafts to the next position. The shafts must be rotated over a minimum of 30° (60° if the distance between the sensors is less than 200 mm).

Green sector shows permitted positions.
Red sector shows forbidden positions.



The reading is taken automatically when the sensors have been stationary for 2 seconds.

Rotate the shafts to the third position.



The reading is taken automatically when the sensors have been stationary for 2 seconds.

TIP: When registering the third reading at the 3 o'clock position, the sensors will already be in the right position for horizontal alignment.

Measurement results



The Measurement Result screen shows the coupling values and foot values in both the vertical and horizontal direction.

The symbol to the left of the coupling values indicates the angular direction and offset, and also if the values are within tolerance.



Within tolerance (green).



Within double tolerance (yellow and inverted).



Out of double tolerance (red and inverted).



When a coupling is in tolerance in one direction, this is indicated with a check symbol at the motor.

The machine picture itself also indicates the coupling alignment.



Save the measurement result.



Go to shimming

Evaluating the result

The angle and offset values are used to determine the alignment quality. These values are compared with the alignment tolerances to determine whether correction is necessary. If suitable tolerances are selected in the tolerance table, the symbols described above indicate if the angle and offset values are within tolerance or not.

The foot values indicate the movable machine's foot positions where corrections can be made.

Shimming



The Shimming screen shows foot values in the vertical direction as suitable shim values (0.05 mm / 1 mils).

The arrows show if shims must be added or removed to adjust the machine in the vertical direction.

The check signs show that shimming is not needed.

When shimming is completed, continue to alignment for adjustments in the horizontal direction.



Go to alignment.

Alignment

If the machine has been adjusted vertically in the shimming screen, go directly to alignment in the horizontal direction.

If the machine has not been adjusted in the shimming screen, alignment in the vertical direction must be done first.



Rotate the shafts to the 12 or 6 o'clock position to adjust in the vertical direction. The angle guide helps you to reach the right position.

Adjust the machine vertically until the values for both angular and parallel alignment are within tolerance. The arrows at the feet show in which direction the machine shall be moved.



Rotate the shafts to the 3 or 9 o'clock position to adjust in the horizontal direction. The angle guide helps you to reach the right position.

Adjust the machine horizontally until the values for both angular and parallel alignment are within tolerance. The arrows at the feet show in which direction the machine shall be moved.

Rotate the shafts back to the 12 or 6 o'clock position and check that the machine is still within tolerance.

Alignment is now completed. To confirm the result, re-do the measurement.



Re-measure.



TRIPPOINT™ METHOD

Select the Tripoint method in Settings.

NOTE: The shafts should be coupled during measurement in order to achieve as reliable and accurate results as possible, when using the Tripoint method.

TIP: The larger the angle over which the three points are measured, the fewer moves, and repeat measurements will have to be made. Minimum angle between readings is 30° (60° if the distance between the sensors is less than 200 mm).

The Tripoint method works in the same way as the Express Mode method, except for measurement point registration.

Enter dimensions

See the Express Mode method.

Measurement point registration



Set the sensors at approximately the same rotational angle at the first measurement position.



Touch the register icon.

This registers the first reading.



Rotate the shafts to the next position. The shafts must be rotated over a minimum of 30° (60° if the distance between the sensors is less than 200 mm).

Green sector shows permitted positions. Red sector shows forbidden positions. The Register icon is not shown if the rotation is less than 30° .



Touch the register icon.

This registers the second reading.



Touch the register icon.

This registers the third reading.

Rotate the shafts to the third position.

TIP: When registering the third reading at the 3 o'clock position, the sensors will already be in the right position for horizontal alignment.

Measurement results

See the Express Mode method.

Evaluating the result

See the Express Mode method.

Shimming

See the Express Mode method.

Alignment

See the Express Mode method.



CLOCK METHOD

Select the **Clock method** in Settings.

The Clock method works in the same way as the **Express Mode** and the **Tripoint method** except for measurement point registration and alignment.

Enter dimensions

See the **Express Mode method**.

Measurement point registration



Set the sensors at approximately the same rotational angle at the first measurement position, 9 o'clock.



Touch the register icon.
This registers the first reading.

Rotate the shafts to the next position, 3 o'clock.

A green sector displays the position.



Touch the register icon.
This registers the second reading.

Rotate the shafts to the third position, 12 o'clock.



Touch the register icon.

This registers the third reading.

Measurement result

See the Express Mode method.

Evaluating the result

See the Express Mode method.

Shimming

See the Express Mode method.

Alignment

If the machine has been adjusted vertically in the shimming screen, go directly to alignment in the horizontal direction.

If the machine has not been adjusted in the shimming screen, alignment in the vertical direction must be done first.



Rotate the shafts to the 12 o'clock position to adjust in the vertical direction. The angle guide helps you to reach the right position.

Adjust the machine vertically until the values for both angular and parallel alignment are within tolerance. The arrows by the feet show in which direction the machine should be moved.



Rotate the shafts to the 3 o'clock position to adjust in the horizontal direction. The angle guide helps you to reach the right position.

Adjust the machine horizontally until the values for both angular and parallel alignment are within tolerance. The arrows by the feet show in which direction the machine should be moved.

Rotate the shafts back to the 12 o'clock position and check that the machine is still within tolerance.

Alignment is now completed. To confirm the result, re-do the measurement.



Re-measure.

FEET LOCK FUNCTION

In some cases, the machine that is displayed as the movable machine is not movable, or maybe some of the feet are not adjustable. In order to perform proper alignment in these cases, the Feet Lock function can be used. This function allows you to select which feet are locked and which feet are adjustable.

Feet Lock is available both in shimming and alignment.



Touch the Feet Lock icon in Configuration to enter the Feet Lock function.

Enter dimensions. The required distances are those between the first and second pairs of feet on the stationary machine and between the first pair of feet on the stationary machine and the first pair of feet on the movable machine.



Select the two pairs of feet you want to lock.

Feet Lock Shimming



Shim values are shown for the two pairs of feet that are not locked.

Feet Lock Alignment



Live values are shown for the two pairs of feet that are not locked.

SPACER SHAFT

The spacer shaft function is used when the alignment is performed on machinery using a membrane coupling. The membrane coupling is a typical high-performance coupling, with no backlash, used for maintenance free operation. It is also suitable for high speeds or high temperature applications.

Membrane couplings are normally designed with a spacer shaft between two flexible elements making it possible to compensate for both axial, radial (offset) and angular misalignment. Each flexible element normally consists of a steel disc pack (diaphragms) which has a high torsional stiffness. A single flexible element can only compensate for angular misalignment and cannot take any radial misalignment. To compensate for all

types of misalignment, the membrane couplings use two flexible elements with a spacer in between.

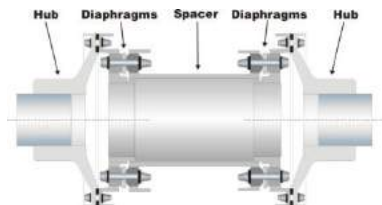

When using the spacer shaft function, the misalignment is presented as an angle for each flexible element. The angles can be compared directly to the figures on allowed misalignment normally delivered from the coupling manufacturer.

Depending upon the alignment condition, there can be differences in angle between the two flexible elements. The pictures below show different examples of how the angles in the flexible elements can be.



Activate spacer shaft in Configuration.

Enter dimensions



Starts sequence for entering dimensions and tolerance.

Measure and enter dimensions and tolerance.

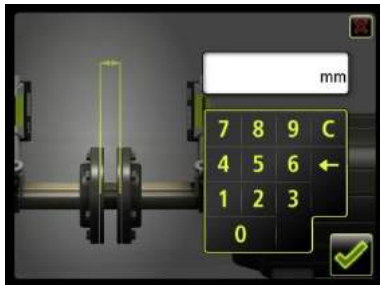

You must enter the distance between the sensors, the “spacer shaft length” and the distance between the “end of the spacer shaft” and the M-sensor. (If you only wish to

check shaft alignment, these are the only necessary distances).

The distance between the M-sensor and the first pair of feet and the distance between the first and the second pairs of feet can be entered now or later (these distances are necessary to provide the feet values).

Measurement point registration

See selected measurement method, the Express Mode method, the Tripoint method or the Clock method.

Measurement results



The Measurement Result screen shows the coupling values and foot values in both the vertical and horizontal direction.

The symbol to the left or right of the coupling values indicates the angular direction, and also if the values are within tolerance.



Within tolerance (green).



Within double tolerance (yellow and inverted).



Out of double tolerance (red and inverted).



When a coupling is in tolerance in one direction, this is indicated with a check symbol at the motor.

The machine picture itself also indicates the coupling alignment.



Save the measurement result.



Go to shimming

Evaluating the result

The angle values are used to determine the alignment quality. These values are compared with the alignment tolerance to determine whether correction is necessary. If suitable tolerance is selected in the tolerance table, the symbols described above indicate if the angle values are within tolerance or not.

The foot values indicate the movable machine's foot positions where corrections can be made.

Shimming

See the Express Mode method.

Alignment

If the machine has been adjusted vertically in the shimming screen, go directly to alignment in the horizontal direction.

If the machine has not been adjusted in the shimming screen, alignment in the vertical direction must be done first.



Rotate the shafts to the 12 or 6 o'clock position to adjust in the vertical direction. The angle guide helps you to reach the right position.

Adjust the machine vertically until the values for both angular values are within tolerance. The arrows at the feet show in which direction the machine shall be moved.



Rotate the shafts to the 3 or 9 o'clock position to adjust in the horizontal direction. The angle guide helps you to reach the right position.

Adjust the machine horizontally until the values for both angular values are within tolerance. The arrows at the feet show in which direction the machine shall be moved.

Rotate the shafts back to the 12 or 6 o'clock position and check that the machine is still within tolerance.

Alignment is now completed. To confirm the result, re-do the measurement.



Re-measure.

OMNIVIEW



OmniView enables the user to automatically see the machine set-up from the actual view (i.e. from the view where the user is standing).

Activate OmniView



Activate OmniView in Settings.

Synchronize OmniView

To use OmniView it has to be synchronized.

1. Place the display unit so that the machine set-up matches the view on the screen.

If necessary, you can change the view in the display unit until it matches the machine set-up.



2. Touch the 'synchronization' icon.



You will now be able to move around the machine and have the view changed automatically depending on the actual orientation of the display unit.



In measurement and live alignment screens you can view the motor from either side (i.e. motor on the right or motor on the left) or from behind. In other screens (i.e. configuration, results etc) you can view the motor from either side, but not from behind.

After use and several view changes the view might become out of synchronization with the real machine. If so, please synchronize again. This is done by touching the 'desynchronization' icon and adjusting the view and then touching the 'synchronization' icon again to restart OmniView.

Calibrate OmniView

Before the first use OmniView need to be field calibrated. This procedure needs to be performed after storage, temperature changes or extensive use.

1. Put the display unit down on a completely stable surface.
2. Press the 'synchronization' icon for 5 seconds.



3. Confirm and wait for the calibration to finish.
Do not hold or touch the display unit during the calibration!

SCREEN FLIP

Screen Flip enables the user to manually see the machine set-up from the actual view.

To use Screen Flip, OmniView has to be deactivated. This is done in Settings.

You will now be able to change the view manually.



EXTENDED ALIGNMENT

Extended alignment makes it possible to align even when it is not possible to rotate the shafts to the 12/6 or 3/9 o'clock positions.



Diagonal red stripes in the back of the value fields indicate that Extended Alignment is activated and that the result values are approximate.

Vertical values are shown at the 12/6 o'clock positions $\pm 45^\circ$. Horizontal values are shown at the 3/9 o'clock positions $\pm 45^\circ$. The values are more accurate within $\pm 15^\circ$ at the 12/6/3/9 o'clock positions.

2-AXIS ALIGNMENT

The 2-axis alignment function allows the user to perform adjustments of the movable machine both in vertical and horizontal direction without further rotations of the shafts.

The 2-axis alignment function is used only when the shaft has limited or no possibility to control the positioning of the shafts during rotation. This software function requires the use of 2-axis receivers (RM and RS) together with laser modules (TM and TS).

Note: This function cannot be used during the following conditions:

- Uncoupled shafts.
- If the shafts rotate during correction.

- If any backlash occurs in the coupling during correction.



The 2-axis alignment screen shows coupling values and foot values in both the vertical and horizontal direction.

HYPERMODE

HyperMode is a function for doing several Horizontal Shaft measurements and get the result as an average of these measurements.

HyperMode can be used with all measurement methods.

When HyperMode is activated a choice will show up after each measurement.



Do another measurement.



Finish and show result.

The result shown will be an average of the measurements that have been done.

OTHER FEATURES

Coupling gap

The result can be presented as a coupling gap.

Activate coupling gap in Configuration.

Enlarge values

On the alignment screen, the coupling values, feet values and sensor values can be enlarged by touching them.

Touch the enlarged values to return them to normal size.

Manual change of view



Manual change between horizontal and vertical view in the Clock method. This disables the inclinometers.

Target Value symbol



When Target Values are used in the measurement, this is indicated with the Target Value symbol in the Measurement, Result and Alignment screens.

Looseness indicator

The system has a function for detecting coupling backlash and looseness in order to achieve optimum accuracy. The system will display the looseness indicator if one of the following conditions is met:

- The M and S units are more than 3° apart.
- The mutual angular position changes more than 0.7° from that when the first measurement point was taken.



When the coupling backlash or looseness is eliminated to avoid any of the above conditions, the looseness indicator will automatically disappear.

It is possible to override the indicator by touching the 'x' in the upper right corner to close the message. The looseness indicator function will then be disabled for the rest of the measurement session.



SHAFT ALIGNMENT VERTICAL MACHINES

INTRODUCTION

Shaft alignment: Determine and adjust the relative position of two machines that are connected, such as a motor and a pump, so that the rotational centers of the shafts are collinear, when the machines are working at a normal operating temperature. Correction of vertical shaft alignment is done by moving the flange of the machine until the shafts are aligned within given tolerances. A tolerance table is available in the system.



The NXA system has two measuring units that are placed on each shaft by using the fixtures supplied with the system.



After rotating the shafts to different measuring positions, the system calculates the relative distance between the two shafts in two planes. The distances between the two measuring planes, distance to the coupling, number of bolts and pitch circle diameter are entered into the system. The display box then shows the actual alignment condition together with the position of the feet. Adjustment of the machine can be

made according to the values displayed. The angular misalignment is corrected by placing shims under the bolts and offset is corrected by moving them laterally.

The alignment results can be saved in the memory manager. The measurements in the memory manager can easily be transferred to a PC for further documentation purposes.

PRE-ALIGNMENT FUNCTIONS

To obtain the best possible conditions for shaft alignment, it is necessary to perform some pre-alignment checks. In many cases it is necessary to make these checks in order to obtain precise alignment. It is often impossible to reach the desired alignment results if you do not make any pre-alignment checks.

Before going on site, check the following:

What are the required tolerances?

Any offsets for dynamic movements?

Are there any restrictions for mounting the measuring system?

Is it possible to rotate the shafts?

What shim size is needed?

Before setting up the alignment system on the machine, check the machine foundation, bolt and shim conditions. Also check if there are any restrictions in adjusting the machine (if e.g. there is enough space to move the machine).

After the visual checks have been performed, there are some conditions that must be considered:

- Check that the machine has the right temperature for alignment?
- Take away old rusty shims (check that you can remove shims).
- Check coupling assembly and loosen the coupling bolts.
- Check soft foot conditions.

- Mechanical looseness.
- Check coupling and shaft run-out.
- Pipe work strain.
- Coarse alignment.
- Check coupling gap (axial alignment).

MOUNTING

The sensors are mounted as described in chapter “Shaft Alignment Horizontal Machines”.

MEASUREMENT METHODS

In the Vertical Shaft Alignment program, there are three different measurement methods, the Express Mode method, the Tripoint method and the Clock method. Select the measurement method in Settings.



Express Mode™ method

In the Express Mode method, the alignment condition can be calculated by recording three points while rotating the shafts at least 60° . After recording the 1st point, the other points are taken automatically when the shafts are rotated to a new position and are kept in position for more than 2 seconds.



Tripoint™ method

In the Tripoint method, the alignment condition can be calculated by taking three points while rotating the shaft at least 60° . In this method, all points are taken manually.



Clock method

In the Clock method, machinery positions are calculated by taking three points with 180° of rotation. The Clock method is useful when comparing the measurement results with traditional alignment methods using dial gauges and reversed rim method. The method can also be used when the machines are standing on non-horizontal foundations or when the shafts are not coupled.

STARTING THE PROGRAM



Start the program by touching the Vertical Shaft Alignment icon in the Main Menu.



Go to Settings for selecting measurement method and other settings.



Go to Configuration to configure the measurement.

SETTINGS



These settings are unique for this application.

For most of the settings, the current selection is shown in the icon.

The functions that are available depend upon which application packages and accessories you have selected.

Measurement method



Opens window for selection of measurement method. Express Mode, Tripoint or the Clock method.

Resolution shown



Opens window for selection of resolution shown.

Resolution shown depends also on connected receiver.

Sampling time



Opens window for selection of sampling time.

A repeatability test can also be made here. See chapter "Repeatability test".

Adjustable screen filter



Opens window for activating or deactivating the adjustable screen filter.

Note: The adjustable screen filter should be deactivated for normal operation, and only activated in environments with severe vibrations.

Sensor Display



Starts Sensor Display. See chapter "Sensor Display".

Global settings



Opens Global settings. See chapter "Global settings".

Confirm



Exits the Settings and returns to the application.

CONFIGURATION

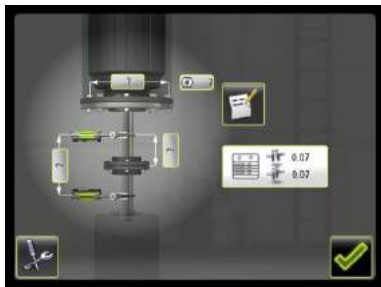

Dimensions



Tolerance table



Opens the tolerance table. See chapter "Tolerance table".

Notes



Opens Notes, where notes can be entered.

Settings



Goes to Settings.

Confirm



Exits the configuration and returns to the application.



EXPRESS MODE™ METHOD

Select the Express Mode method in Settings.

NOTE: The shafts should be coupled during measurement in order to achieve as reliable and accurate results as possible, when using the Express Mode method.

TIP: The larger the angle over which the three points are measured, the fewer moves, and repeat measurements will have to be made. Minimum angle between readings is 30° (60° if the distance between the sensors is less than 200 mm).

Enter dimensions



The screen displays the movable machine. The traffic lights show green when the laser hits the detector.



Starts sequence for entering dimensions and tolerance.

Measure and enter dimensions and tolerance.

You must enter the distance between the sensors, and the distance between the center of the coupling and the M-sensor. (If you only wish to check if the shafts are aligned, these are the only distances necessary.)

Entering the pitch circle diameter and the number of bolts can be done now or later (this is necessary in order to obtain the bolt values).

Up to 256 bolts can be entered.

Measurement point registration

Before starting the measurement, you must select a bolt to be bolt number 1.

The first measurement position must be at bolt number 1.



Set the sensors at approximately the same rotational angle at the first measurement position, at bolt number 1.



Touch the register icon.

This starts the measurement point registration and registers the first reading.

Rotate the shafts to the next position. The shafts must be rotated over a minimum of 30° (60° if the distance between the sensors is less than 200 mm).

Green sector shows permitted positions.
Red sector shows forbidden positions.



The reading is taken automatically when the sensors have been stationary for 2 seconds.

Rotate the shafts to the third position.



The reading is taken automatically when the sensors have been stationary for 2 seconds.

Measurement result



The Measurement Result screen shows the coupling values in both directions, and bolt values.

The symbol to the left of the coupling values indicates the angular direction and offset, and also if the values are within tolerance.



Within tolerance (green).



Within double tolerance (yellow and inverted).



Out of double tolerance (red and inverted).



When a coupling is in tolerance in one direction, this is indicated with a check symbol at the motor.

The machine picture itself also indicates the coupling alignment.



Save the measurement result.



Go to shimming

Evaluating the result

The angle and offset values are used to determine the alignment quality. These values are compared with alignment tolerances to determine if any correction is necessary. If suitable tolerances are selected in the tolerance table, the symbols described above indicate if the angle and offset values are within tolerance or not.

The foot values indicate the movable machine's foot positions where corrections can be made.

Shimming



The Shimming screen shows bolt values as suitable shim values (0.05 mm / 1 mils).

Adjust the angular error by placing shims under the bolts as required.

The arrow shows if shims must be added to adjust the machine.

The check sign shows that shimming is not needed.

When shimming is completed, continue to alignment for adjustments of parallel offset.



Go to alignment.

Alignment



If the angular error has been correctly adjusted in the shimming screen the angular value should now be in tolerance.

Now adjust the parallel offset in both directions. The parallel offset is displayed live in the first direction when the sensors are placed in position number 1, and in the

second direction when they are placed in position number 2.

Check that both the angular value and the parallel offset are within the required tolerances once the adjustments are completed.

Alignment is now complete. To confirm the result, re-do the measurement.



Re-measure.



TRIPPOINT™ METHOD

Select the Tripoint method in Settings.

NOTE: The shafts should be coupled during measurement in order to achieve as reliable and accurate results as possible, when using the Tripoint method.

TIP: The larger the angle over which the three points are measured, the fewer moves, and repeat measurements will have to be made. Minimum angle between readings is 30° (60° if the distance between the sensors is less than 200 mm).

The Tripoint method works in the same way as the Express Mode method, except for measurement point registration.

Enter dimensions

See the Express Mode method.

Measurement point registration

Before starting the measurement, you must select a bolt to be bolt number 1.

The first measurement position must be at bolt number 1.



Set the sensors at approximately the same rotational angle at the first measurement position, at bolt number 1.



Touch the register icon.

This registers the first reading.

Rotate the shafts to the next position. The shafts must be rotated over a minimum of 30° (60° if the distance between the sensors is less than 200 mm).

Green sector shows permitted positions. Red sector shows forbidden positions. The Register icon is not shown if the rotation is less than 30° .



Touch the register icon.

This registers the second reading.



Touch the register icon.

This registers the third reading.

Rotate the shafts to the third position.

Measurement results

See the Express Mode method.

Evaluating the result

See the Express Mode method.

Shimming

See the Express Mode method.

Alignment

See the Express Mode method.



CLOCK METHOD

Select the **Clock method** in Settings.

The Clock method works in the same way as the **Express Mode** and the **Tripoint method** except for measurement point registration.

Enter dimensions

See the **Express Mode method**.

Measurement point registration

Place yourself at the position corresponding to the second measurement position, where it is easiest to turn the shafts through 180° .

The first measurement position must be at bolt number 1.

Tip: Mark the positions 1, 2 and 3 before you start measuring.

NOTE: The rotational angle from the sensors are not used in the Clock method in the Vertical Shaft Alignment program.



Set the sensors at approximately the same rotational angle at the first measurement position, with bolt number 1 to the right.



Touch the register icon.

This registers the first reading.

Rotate the shafts 90° to the second position (where you are standing).

A green sector displays the position.



Touch the register icon.

This registers the second reading.

Rotate the shafts 90° to the third position, to the left.

A green sector displays the position.



Touch the register icon.

This registers the third reading.

Measurement result

See the Express Mode method.

Evaluating the result

See the Express Mode method.

Shimming

See the Express Mode method.

Alignment

See the Express Mode method.

NOTE: The rotational angle from the sensors are not used in the Clock method in the Vertical Shaft Alignment program.



SHAFT ALIGNMENT OFFSET MACHINES

INTRODUCTION

The most common set-up for offset machines is the Z-configuration, where the drive shaft and the driven unit should have rotational centers that are parallel to each other. This configuration can appear in both horizontally and vertically mounted machines.

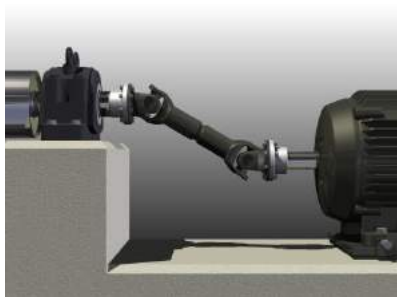

The Offset laser fixture is adjustable in a plane parallel to the stationary machine's flange face and can be set at any position to eliminate the offset from the driven unit. The dummy rotational center on the fixture is set in front of the driven unit and any angular misalignment is measured by using the sensors in the NXA system.

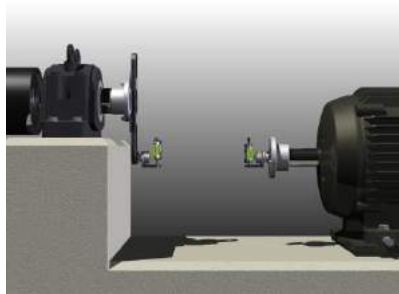

- Precision alignment using the NXA system.

Alignment of offset machines with the NXA system involves the following:

- Pre-alignment.
- Mounting the fixtures to eliminate the offset between the rotational centers.
- Coarse alignment using the built-in lasers.

PRE-ALIGNMENT

The machined parts of the Offset fixture allow the dummy axis to be set parallel with a tolerance of better than 0.2 mm per meter. However, if the flange face is deformed, not truly flat, or has a run-out, the accuracy of the system can be compromised. It is important that the flange is clean and that all high spots are removed before mounting the fixtures on the flange. It is also important to use the spacers and washers that are included in the fixture system according to the instructions mentioned in the mounting section of this manual.

Perform the following actions before mounting the fixture on the flange:

- Dismount the covers and remove the cardan shaft.
- Remove all high spots, such as burs from the bolt holes, and clean the flange faces.
- Check the run-out on the flange faces, using a dial indicator.
- Lock the shaft of the stationary machine before mounting the fixture on the flange.

MOUNTING

Mounting (Stationary)

The Offset fixture comes with a number of methods of attachment. The system is designed so that you can utilize the coupling bolts themselves in most cases when mounting the arm on the flange. Remember to place the steel spacers between it and the face before bolting up. This helps to eliminate any problems with high spots on the surface. The arm can be fixed at any point across the face, but placing it at the outer diameter, rather than across the center, secures the fixture arm over a longer distance and increases the stability. The offset and the space available determine the set-up of the fixture arrangement. The figures below show different ways of

mounting the fixture on the stationary machine.

Mounting the fixture with 2 arms is the most flexible set-up, which also covers the entire range in terms of offset.



1. Clean the flange and mount the inner arm on the flange. Make sure to use the hardened washers as spacer between the arm and flange. Try to have as much distance between the two bolts as possible. Use the bolts from the cardan shaft (maximum M12 Allen screw) together with the guide washers to fix the arm on the flange. Make sure that the arm has maximum contact surface, equally distributed across the width, with the hardened washers, and that the arm is properly fastened on the flange.
2. Mount the 2nd arm with the turret onto the 1st arm, using the M10 bolt and guide washer. By slightly tightening the arm; it is possible to adjust its

position roughly in front of the movable unit.

3. Make sure to tighten the bolt that connects the two arms before the fixture is left unsupported.



Mounting alternatives (Stationary)

In applications where the flange can be rotated, where access is limited, or where you cannot use the "2-arm set-up", it is possible to mount just one arm on the flange.

- Mount the arm on the flange and rotate the flange to a position where the "dummy axis" of the turret can hit the center of the movable machine.
- Make sure to lock the stationary unit in this position to prevent any movement of the flange.
- Make the final adjustment of the arm until the "dummy axis" of the turret hits the center of the movable machine.
- Tighten the arm's fastening bolts.

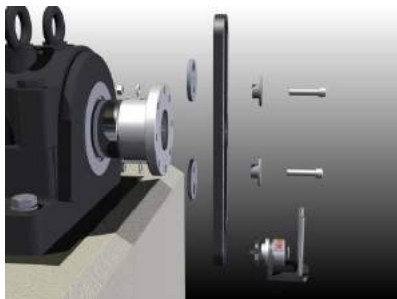

For applications with a small offset, you sometimes must mount the turret close to the center and in between the fastening bolts on one arm. In this case, it is necessary to dismount the turret at the end and place it in the center thread on the arm.

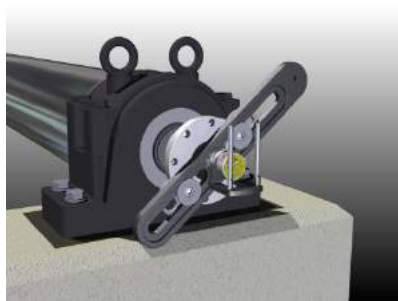

Mounting (Movable)

To attach the turret on the movable machine, the kit is provided with a selection of threaded nuts which will fit common coupling faces that have a threaded hole in the shaft center. These can be used to secure the turret to the flange face. The adaptors are only used to mount the turret onto shafts that can be rotated. When performing the measurement, it is important to rotate the machine shaft and not the turret itself.

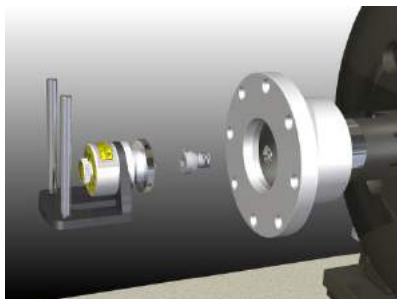

Mounting alternatives (Movable)

If no thread is present in the shaft center of the movable machine, the M-sensor can be mounted by using the chain fixture, extension bracket (optional) and the longer rods from the NXA system. The chain fixture is attached to the flange. The extension bracket is mounted on the chain fixture so that the rods are positioned in front of the flange.

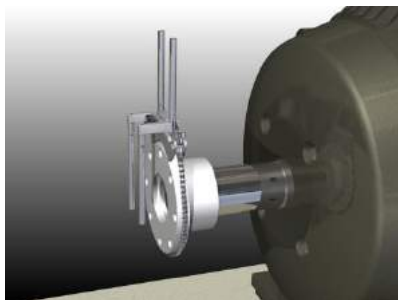

If the shaft cannot be rotated, an extra arm can be mounted in front of the flange. The threaded hole in the center of the arm should be positioned near the center of the shaft. Try to have as much distance as possible between the fastening points.

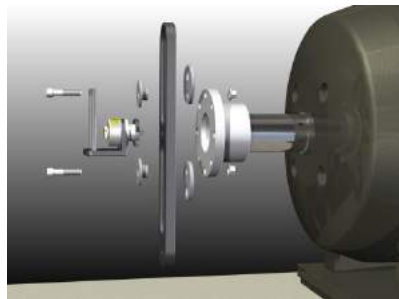

COARSE ALIGNMENT

The purpose of coarse alignment is to align the machines roughly by using the built-in lasers.

The built-in lasers in each turret are pre-adjusted so that the laser beam represents the axis of rotation for the unit it is mounted on.

1. Turn on the built-in laser in the turret on the stationary side, by rotating the laser unit clockwise until it bottoms.

The lasers may cause interference with each other, so it is recommended that the laser pointers are turned on one at a time.



2. Rotate the turret on the stationary side and make sure that the laser beam hits the same spot (within 2 mm). If not, adjust the built-in laser according to steps 5-12.
3. Loosen fastening screw and adjust the position of the arm until the laser beam hits the target center on the movable machine. Tighten and verify that the

laser beam is still hitting the center of the target.

4. Turn off the laser in the turret on the stationary side.
5. Turn on the laser in the turret on the movable machine.
6. Turn the turret until it is standing in a vertical position.

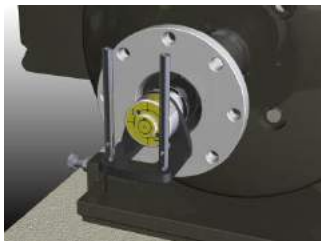

7. Aim the laser onto a target (a piece of paper or cardboard). Make a mark where the laser beam hits.



8. Rotate the **shaft** 180° .

Note: On the movable side, the shaft should be rotated, not just the turret.

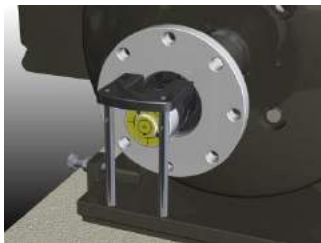

When using this procedure on the stationary side, only the turret shall be rotated 180°.

9. The laser spot should now have moved on the surface, in a pattern of a half circle.

Make a 2nd mark where the laser beam hits the target.

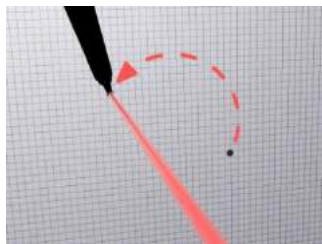

10. Make a 3rd mark on the target at half the distance between the 1st and 2nd mark.

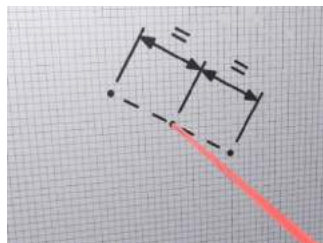

11. Adjust the position of the laser beam until it is hitting the 3rd marking on the target, using the two adjustment screws on the front on the turret. Make sure not to rotate the turret during the adjustment of the laser.
12. Repeat the coning process until the circle is a single spot on the surface during rotation of the shaft.

13. Make a coarse adjustment of the movable machine. Loosen the bolts and adjust the movable machine until both lasers are in the center of each opposing target.
14. If necessary, re-adjust the arm position to get both lasers in the center of the targets.

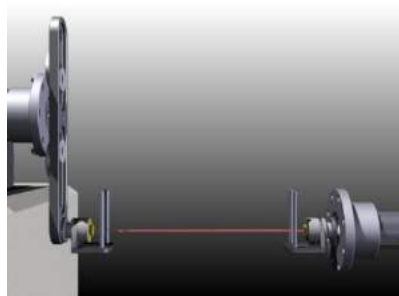

STARTING THE PROGRAM



Start the program by touching the Offset Shaft Alignment icon in the Main Menu.



Go to Settings for selecting settings.



Go to Configuration to configure the measurement.

SETTINGS



These settings are unique for this application.

For most of the settings, the current selection is shown in the icon.

The functions that are available depend upon which application packages and accessories you have selected.

Resolution shown



Opens window for selection of resolution shown.

Resolution shown depends also on connected receiver.

Sampling time



Opens window for selection of sampling time.

A repeatability test can also be made here. See chapter “Repeatability test”.

Adjustable screen filter



Opens window for activating or deactivating the adjustable screen filter.

Note: The adjustable screen filter should be deactivated for normal operation, and only activated in environments with severe vibrations.

Sensor Display



Starts Sensor Display. See chapter "Sensor Display".

Global settings



Opens Global settings. See chapter "Global settings".

Confirm



Exits the Settings and returns to the application.

CONFIGURATION



Dimensions

?

Tolerance table



Opens the tolerance table. See chapter "Tolerance table".

Result presentation



Opens window for selection of distance to present the angular misalignment at.

Softcheck™



Starts Softcheck. See chapter "Softcheck".

Notes



Opens Notes, where notes can be entered.

Settings



Goes to Settings.

Confirm



Exits the configuration and returns to the application.

MEASUREMENT

Measurement method

The Clock method is used to provide the result. In the Clock method, machinery positions are calculated by taking three points with 180° of rotation.

Enter dimensions

The screen displays the movable machine.
The traffic lights show green when the laser hits the detector.



Starts sequence for entering dimensions and tolerance.

Measure and enter dimensions and tolerance.



You must enter the distance between the sensors. (If you only wish to check shaft alignment, this is the only necessary distance).



The distance between the first and the second pairs of feet can be entered now or later (this distance is necessary to provide the feet values).

Measurement point registration



Set the sensors at approximately the same rotational angle at the first measurement position, 9 o'clock. For best result, the rotational angles of the two sensors should be within 0.5° .



Touch the register icon.

This registers the first reading.

Rotate the shafts to the next position, 3 o'clock.

A green sector displays the position.



Touch the register icon.

This registers the second reading.

Rotate the shafts to the third position, 12 o'clock.



Touch the register icon.

This registers the third reading.

Measurement results



The Measurement Result screen shows the coupling value and feet values in both the vertical and horizontal direction.

The symbol to the left of the coupling values indicates the angular direction, and also if the values are within tolerance.



Within tolerance (green).



Within double tolerance (yellow and inverted).



Out of double tolerance (red and inverted).



When a coupling is in tolerance in one direction, this is indicated with a check symbol at the motor.

The machine picture itself also indicates the coupling alignment.



Save the measurement result.



Go to shimming

Evaluating the result

The angle value is used to determine the alignment quality. This value is compared with the alignment tolerances to determine whether correction is necessary. If suitable tolerances are selected in the tolerance table, the symbols described above indicate if the angle value is within tolerance or not.

The feet values indicate the movable machine's foot positions where corrections can be made.

Shimming



The Shimming screen shows foot values in the vertical direction as suitable shim values (0.05 mm / 1 mils).

The arrows show if shims must be added or removed to adjust the machine in the vertical direction.

The check signs show that shimming is not needed.

When shimming is completed, continue to alignment for adjustments in the horizontal direction.



Go to alignment.

Alignment

If the machine has been adjusted vertically in the shimming screen, go directly to alignment in the horizontal direction.

If the machine has not been adjusted in the shimming screen, alignment in the vertical direction must be done first.

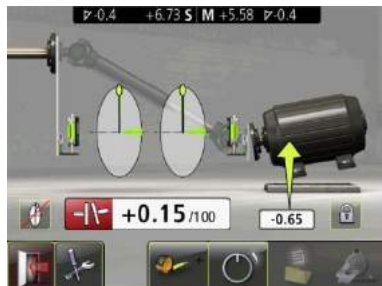

Rotate the shafts to the 12 or 6 o'clock position to adjust in the vertical direction. The angle guide helps you to reach the right position.

Adjust the machine vertically until the value for angular alignment is within tolerance. The arrows at the feet show in which direction the machine shall be moved.



Rotate the shafts to the 3 or 9 o'clock position to adjust in the horizontal direction. The angle guide helps you to reach the right position.

Adjust the machine horizontally until the value for angular alignment is within tolerance. The arrows at the feet show in which direction the machine shall be moved.

Rotate the shafts back to the 12 or 6 o'clock position and check that the machine is still within tolerance.

Alignment is now completed. To confirm the result, re-do the measurement.



Re-measure.

OTHER FEATURES

Enlarge values

On the alignment screen, the coupling values, feet values and sensor values can be enlarged by touching them.

Touch the enlarged values to return them to normal size.

Change feet reference

The feet reference can be changed by touching the lock.



Touch the lock to change feet reference.

LASER POINTERS

Individually adapted

The laser pointers are individually adapted to their housings and should not be switched with each other.

Changing batteries

When the laser spot slowly starts to fade away, it is time to change the batteries.

Dismount the laser pointer from the turret and open the end cap of the laser device.

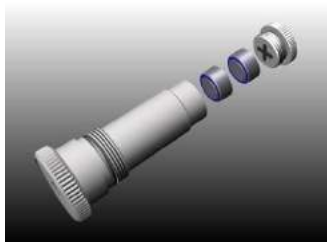

Use two SR44 batteries per device, + on the batteries must face the cap (LR44 can also be used, but they only have approximately half the capacity of the SR44).



MACHINE TRAIN ALIGNMENT

INTRODUCTION

A machine train is a set-up of more than two rotating machines that are connected to each other. A typical machine train application is a motor which drives machinery with a gearbox in between.

When alignment is performed on machine trains, adjustment of one machine will directly affect the alignment of the other machines. Before making any adjustment in a machine train, it is important to know the relative position of each machine in the train. When this is known it is easy to get an

overview of the machine train to see which adjustments are needed to align all the machines.

The amount of adjustment needed depends on which machine in the machine train is selected as the stationary machine. In many cases there are also restrictions to the amount of adjustment due to base or bolt bound conditions, which influence the choice of the stationary machine.



Machine Train with 3 machines.

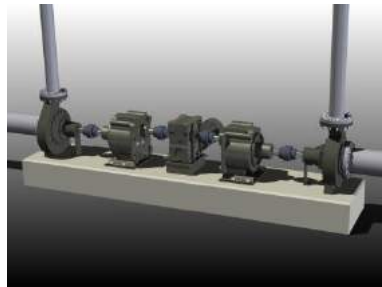

Machine Train with 5 machines.

The machine train program in NXA is especially designed to quickly provide an overview of the position of each machine and to determine which machine should be chosen as stationary, in order to optimize the work with adjustments.

Functions in the program make it possible to align machines to target positions, i.e. Target Values, and to calculate the minimum amount of adjustment to align the entire machine train.

Once the stationary machine has been chosen, the alignment of the rest of the units is performed by using the program for horizontal machines. See also chapter "Shaft Alignment Horizontal Machines".

MOUNTING

Mounting of the sensors is done as described in chapter "Shaft Alignment Horizontal Machines".

It is important to place the sensors for the stationary and the movable machine on the same side of every coupling.

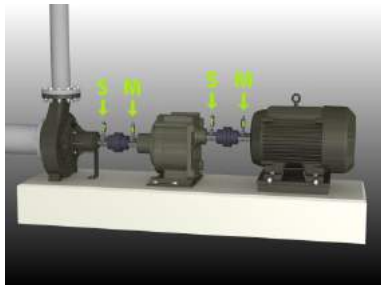

Try to always be on the same side of the machine train when mounting the sensors, to avoid making any mistakes.

PRE-ALIGNMENT FUNCTIONS & ACTIVITIES

To minimize the time for measurements on site, it is recommended to pre-set the configuration of the machine (distances, machine-ID and target values) and save the configuration in the memory.

On site, you simply open the configuration from the memory manager and continue with the measurements for each coupling.

For alignment of machine trains, it is important to do some on-site pre-alignment activities besides the ones described in the chapter “Shaft Alignment Horizontal Machines”.

- Check the amount of adjustment possible for every machine.

- Check if there is any bolt or base-bound restrictions.
- Check if there are any restrictions to moving the machine due to attached piping, electrical cables, hydraulics or similar equipment.

STARTING THE PROGRAM



Start the program by touching the Machine Train Alignment icon in the Main Menu.

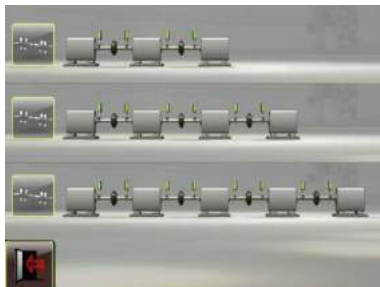

The screen displays machine trains with 3, 4 or 5 units.



Touch the icon for the machine train that corresponds to your application.



Go to Settings for selecting measurement method, and other settings.

SETTINGS

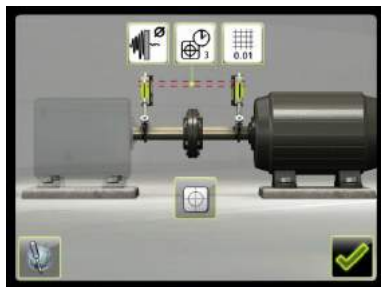

These settings are unique for this application.

For most of the settings, the current selection is shown in the icon.

The functions that are available depend upon which application packages and accessories you have selected.

Resolution shown



Opens window for selection of resolution shown.

Resolution shown depends also on connected receiver.

Sampling time



Opens window for selection of sampling time.

A repeatability test can also be made here. See chapter “Repeatability test”.

Adjustable screen filter



Opens window for activating or deactivating the adjustable screen filter.

Note: The adjustable screen filter should be deactivated for normal operation, and only activated in environments with severe vibrations.

Sensor Display



Starts Sensor Display. See chapter "Sensor Display".

Global settings



Opens Global settings. See chapter "Global settings".

Confirm



Exits the Settings and returns to the application.

Settings and functions in Shaft Alignment for Machine Train

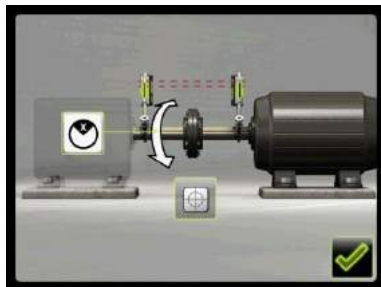

The Machine Train program has a separate settings menu for Shaft Alignment.

Measurement method can only be reached from there.

Measurement method



Opens window for selection of measurement method. Express Mode, Tripoint or the Clock method.

Sensor Display



Starts Sensor Display. See chapter "Sensor Display".

Confirm



Exits the Settings and returns to the application.

CONFIGURATION

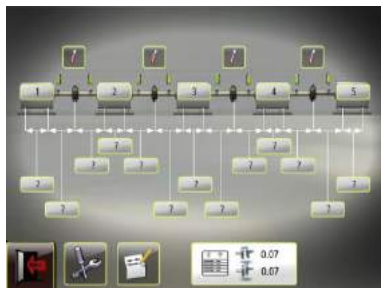

Enter dimensions

 Touch the icon to enter dimensions.

Measure and enter dimensions.

All dimensions must be entered before you can start measuring.

At each unit (except for the end units), there are three distances to enter.



The distance between the center of the coupling and the first pair of feet.

The distance between the first and the second pairs of feet.

The distance between the second pair of feet and the center of the coupling.

Tolerance table



Opens the tolerance table. See chapter "Tolerance table".

Machine ID

Machine ID for the units is preset to 1, 2, 3... but you can change this to something else.

2

Touch the icon for changing machine ID.

Target values



Opens Target values. See chapter "Target values".

Touch the Target Value icon at the coupling where the target values are to be entered.

The target values can be entered as feet values or angle and offset values, but the result for machine train will

always be presented as angle and offset values.

Notes



Opens Notes, where notes can be entered.

Settings



Goes to Settings.

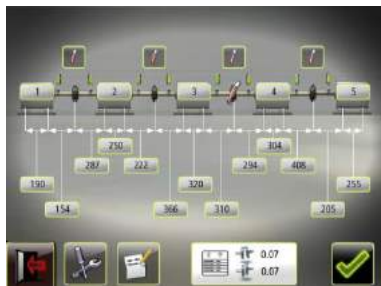

Confirm



Confirms the configuration and continues to summary screen.

Save configuration

The configuration of the machine (distances, machine-ID and target values) can be saved separately, to be opened later. This is done in the summary screen.

Configuration in Shaft Alignment for Machine Train



The Machine Train program has a separate configuration menu for Shaft Alignment.

Softcheck can only be reached from there.

Softcheck™



Starts Softcheck. See chapter "Softcheck".

MEASUREMENT

Summary screen

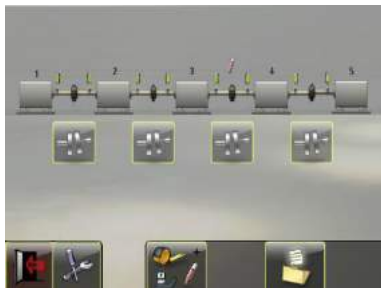

When the configuration has been confirmed, the summary screen is shown.



Touch the save icon to save the configuration.

In the Machine Train program, a shaft alignment measurement is first performed at each coupling. The results from all the couplings are then summarized to a total result for the train.

A part of the Horizontal Shaft Alignment program is used to measure at each coupling.



Touch the Horizontal Shaft Alignment icon to measure at a coupling.

Shaft alignment for machine train

See also chapter "Shaft Alignment Horizontal Machines".

All the measurement methods that can be used for Shaft Alignment of Horizontal machines can also be used here.

The distance between the sensors and the distance between the center of the coupling and the M-sensor must be entered for each coupling. (The distance between the M-sensor and the first pair of feet and the distance between the first and the second pairs of feet are not needed here).

On the result screen for the coupling, only coupling values are shown.



When a coupling is measured, the icon for Shaft Alignment at that coupling is replaced by a re-measuring icon in the summary screen.



When all the couplings have been measured, the result screen for the train will be shown.

MEASUREMENT RESULTS



Result screen with coupling values.

The Measurement Result screen shows coupling values and foot values in both the vertical and horizontal direction.

One of the units is automatically set to reference according to the Minimum Moves function.

The reference can be changed by touching the lock icons.

The symbol to the left of the coupling values indicates the direction of the angle and the offset, and also if the values are within tolerance.



Within tolerance (green).



Within double tolerance (yellow and inverted).



Out of double tolerance (red and inverted).



When a coupling is in tolerance in one direction, this is indicated with a check symbol.

The machine picture itself also indicates the coupling alignment.



Save the measurement result.



Change between viewing the coupling values and the feet values.



Re-measure (This icon returns you to the summary screen.)



Change configuration.



Minimum Moves (a reference based on the Minimum Moves function will be selected).



Select another reference.



Result screen with feet values.

EVALUATING THE RESULT

The angle and offset values are used to determine the alignment quality. These values are compared with alignment tolerances to determine if any correction is necessary. If suitable tolerances are selected in the tolerance table, the symbols described above indicate if the angle and offset values are within tolerance or not.

The feet values give the movable machine's position at the feet where corrections can be made.

ALIGNMENT

Once you have decided which machine to use as a reference, the Horizontal Shaft Alignment program can be used to align the machines.

See the chapter "Shaft Alignment Horizontal Machines".

OTHER FEATURES

Minimum Moves

The **Minimum Moves** function selects the reference machine that involves the smallest amount of adjustment.

In the calculations for this function, priority is given to minimizing horizontal adjustments and removal of shims.



If you touch the **Minimum Moves** icon, a reference will be selected based on the **Minimum Moves** function.

Target Value symbol



When **Target Values** are entered at a coupling, this is indicated with the **Target Value** symbol at that coupling.



SOFTCHECK™

INTRODUCTION

A soft foot condition needs to be corrected before any alignment takes place. If not, the measurement result will be of no value. It is more or less impossible to establish if there is a soft foot condition without using some kind of measurement tool. The Softcheck program checks each foot and displays the result in mm or mils.

The Softcheck program is entered from the Main Menu or from Settings in the Application program.

STARTING THE PROGRAM



Start the Softcheck by touching its icon in the Main menu or the Settings.



Go to Settings for selecting settings.

ENTER DIMENSIONS



Place the TD-units at the 12 o'clock position.



Starts sequence for entering dimensions and tolerance.

Measure and enter dimensions.

You must enter the distance between the sensor units, the distance between the M-unit and the first pair of feet, and the distance between the first and the second pairs of feet, before checking for soft foot.

Check that all foot bolts are firmly tightened.

MEASUREMENT VALUE REGISTRATION



Select a bolt of your choice by touching its icon.

1. Loosen the bolt fully and wait a few seconds.
2. Tighten the bolt firmly, preferably with a dynamometric wrench.

3. Register the measurement value.



Register the measurement value by touching the confirmation icon.



Continue with the rest of the bolts.

Re-measurements can be done at any time by touching the icon for the requested bolt again.

MEASUREMENT RESULT AND CORRECTIONS



Make the necessary corrections and then check each foot again (the values show approximately how many shims that are needed to eliminate the soft foot).

DOCUMENT THE RESULT



Touch the save icon to save the measurement result.

SHAFT ALIGNMENT



Go to shaft alignment by touching this icon.



SOFTCHECK ROP

INTRODUCTION



A soft foot condition needs to be corrected before any alignment takes place. If not, the measurement result will be of no value. It is more or less impossible to establish if there

is a soft foot condition without using some kind of measurement tool. The Softcheck ROP program checks each foot and displays the result in mm or mils.

The Softcheck ROP program is entered from the Main Menu.

STARTING THE PROGRAM



Start the Softcheck ROP by touching its icon in the Main menu.



Go to Settings for selecting settings.

MEASUREMENT VALUE REGISTRATION



Select a bolt of your choice by touching its icon.

1. Loosen the bolt fully and wait a few seconds.
2. Tighten the bolt firmly, preferably with a dynamometric wrench.

3. Register the measurement value.



Register the measurement value by touching the confirmation icon.



Continue with the rest of the bolts.

Re-measurements can be done at any time by touching the icon for the requested bolt again.

MEASUREMENT RESULT AND CORRECTIONS



Make the necessary corrections and then check each foot again (the values show approximately how many shims that are needed to eliminate the soft foot).

DOCUMENT THE RESULT



Touch the save icon to save the measurement result.



TARGET VALUES

INTRODUCTION

Most machines develop a certain amount of heat while running. In the best case both the driving and the driven machine are affected equally requiring no input of compensation values. But in some applications the driven machine is either hotter, i.e. a pump for hot liquid, or cooler than the driving machine.

Machine manufacturers define the thermal expansion of machines differently, but in most cases, you will find it as a factor of deliberate misalignment expressed in parallel offset and angular error.

In the NXA system, you can pre-set target values before starting your alignment work. Accepted values are feet values and angle and offset values.

The entered values are target values. Target values mean that these are the values at which the machine should be positioned when not running (cold condition) in order to obtain correct alignment while the machine is running (hot condition).

STARTING THE PROGRAM



Start the Target Values program by touching the icon in the Main Menu or Configuration.



Select one of two ways to express the offset values: Feet values or angle and offset values.

FEET VALUES

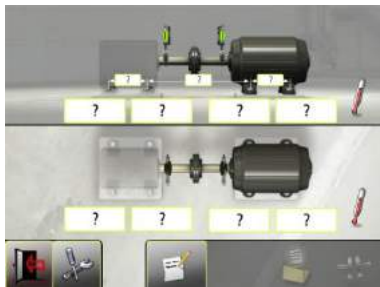

Touch the feet value boxes. Enter target values for the feet in mm or mils according to the pre-set measurement unit together with the required distances.



In the example above, the stationary machine will shrink vertically by 0.12 mm at the rear feet and 0.09 mm at front feet while the movable machine will expand 0.04 mm while running.

Horizontally, the rear feet will move 0.05 mm towards you and the front feet will move 0.03 mm away from you while the movable machine does not change its position while running.

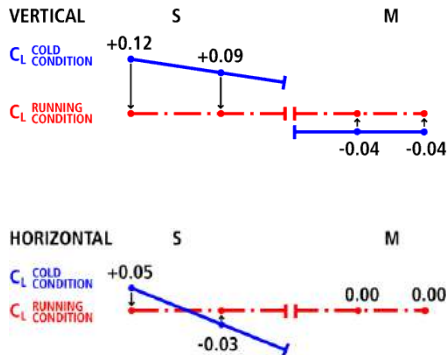

After having entered these feet values, the system calculates how the movable machine should be positioned (target position) in cold condition in order to obtain perfect alignment during running condition.

ANGLE AND OFFSET VALUES

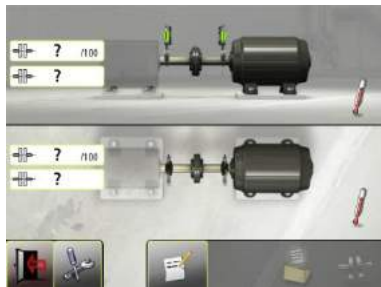

Touch the value boxes and enter target values for the angles in mm/100 mm and target values for the offsets in mm, or mils/inch and mils, according to the pre-set measurement unit.

Coupling gap can be entered if this has been activated in the Settings.



In the example above, the movable machine should be vertically adjusted to a position with an angular misalignment of +0.05 mm/100 mm and an offset of -0.06 mm.

Horizontally, the movable machine should be positioned with a +0.02 mm/100 mm angular misalignment and a +0.03 mm offset, in cold condition to obtain perfect alignment while running.

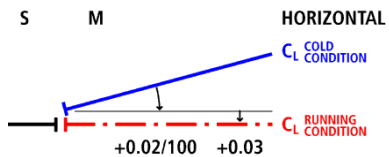
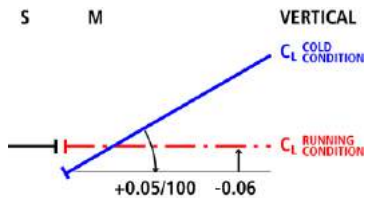

DOCUMENT THE TARGET VALUES



Touch the save icon to save the target values.

SHAFT ALIGNMENT



Go to shaft alignment by touching this icon.



OL2R (OFF LINE TO RUNNING)

INTRODUCTION

If you have unexplainable vibrations in your pump-motor installation, this application can help reduce your doubts (and your vibrations).

OL2R measurements use a special fixture that allows measurement while the machine is running. In this way, both the thermal influences and the load that is put into the pump as well as movement in foundations and pipe strains will be considered.

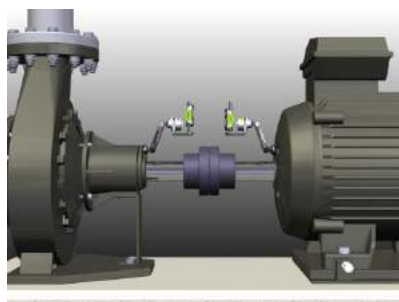
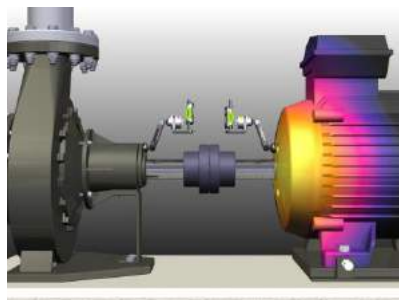

In order to determine dynamic movements, the OL2R laser fixtures are mounted on the two machines that are to be checked. The turrets make it possible to measure the alignment between the two "dummy" axes, by using the NXA system. The measurement is performed in both running and cold condition and the system calculates the difference in alignment, determined as dynamic movements between the machine's two conditions, and is expressed as target values. These target values can be used when the actual shaft alignment is performed.

IMPORTANT NOTES!

- It is very important that you do not remove or adjust the fixtures between the measurements in hot and cold condition.
- If the OL2R fixtures are mounted in a harsh environment, we strongly recommend that the laser pointer is dismantled from the fixture after it has been adjusted.
- The lasers may cause interference with each other, so it is recommended that the laser pointers are turned on one at a time.



WARNING!

Make sure that all safety equipment is fully mounted on the machine before starting the measurement. Cables must be kept away from couplings and other moving parts.



WARNING!

Make sure to fully comply with the local safety regulations for rotating machinery.

MOUNTING & COARSE ALIGNMENT

1. Choose a location on the machine casing (or bearing housing) where the fixtures can maintain a clear line-of-sight and where the turrets can be rotated freely with the measuring units in place. Try to mount the fixtures as close as possible to the rotational axis of both machines.

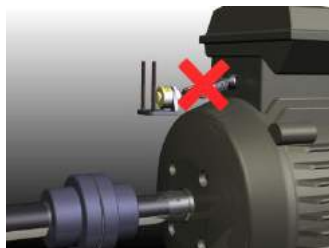
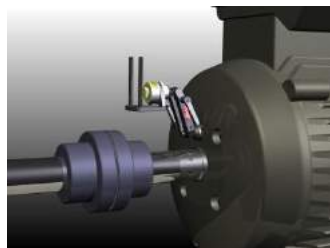

2. Obtain permission to drill and tap a M6 thread (or 1/4" UNC) with a depth of 15 mm (0.6").

3. Mount the tooling ball on each machine. Ensure that the bolt is tightened, and that the arrangement is firmly mounted on the machine casing.

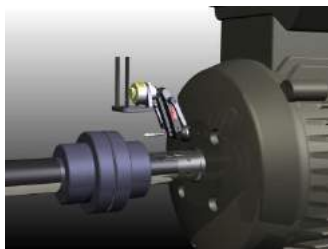

Mounting with OL2R adapter (optional):

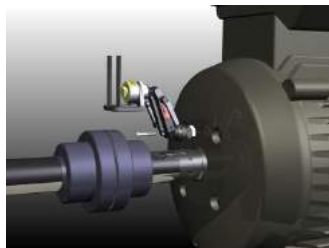

4. Turn on the built-in laser in the turret, by rotating the laser unit clockwise until it bottoms.

The lasers may cause interference with each other, so it is recommended that the laser pointers are turned on one at a time.



5. Check that the laser is adjusted to the rotational center by rotating the turret on each fixture. The projected laser beam should stay on the same spot during rotation (within 2 mm). If not, adjust the laser beam according to the procedure described at the end of this chapter.



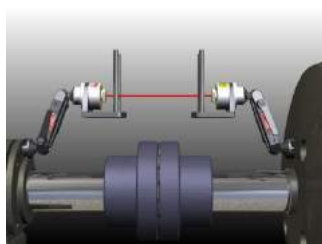

6. Adjust the fixtures until both the lasers hit the center of the opposing target. Tighten the screw on the fixture and make sure that it is stable while rotating the turrets.
7. Turn off the laser beams in the fixtures and mount the NXA sensors on the fixture rods. Make sure that the unit marked M is mounted on the movable machine and the S unit is mounted on the stationary machine.

STARTING THE PROGRAM



Start the program by touching the OL2R icon in the Main Menu.



Go to Settings for selecting settings.



Go to Configuration to configure the measurement.

SETTINGS



These settings are unique for this application.

For most of the settings, the current selection is shown in the icon.

The functions that are available depend upon which application packages and accessories you have selected.

Resolution shown



Opens window for selection of resolution shown.

Resolution shown depends also on connected receiver.

Sampling time



Opens window for selection of sampling time.

A repeatability test can also be made here. See chapter “Repeatability test”.

Adjustable screen filter



Opens window for activating or deactivating the adjustable screen filter.

Note: The adjustable screen filter should be deactivated for normal operation, and only activated in environments with severe vibrations.

Sensor Display



Starts Sensor Display. See chapter "Sensor Display".

Global settings



Opens Global settings. See chapter "Global settings".

Confirm



Exits the Settings and returns to the application.

CONFIGURATION

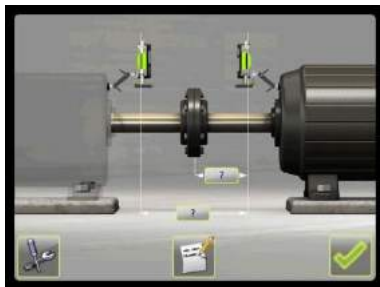

Dimensions



Notes



Opens Notes, where notes can be entered.

Settings



Goes to Settings.

Confirm



Exits the configuration and returns to the application.

MEASURING OL2R

Measurement Method

In the OL2R program, a measurement is made in cold condition (machine off line) and another one in hot condition (machine running) to provide the target values.

The Clock method is used to provide the result in each condition. In the Clock method, machinery positions are calculated by taking three points with 180° of rotation.

The target values are calculated by subtracting the measurement result in cold condition from the measurement result in hot condition.

You can measure the conditions in optional order and the cold and hot conditions can both be saved separately.

Enter dimensions

The screen displays the movable machine.
The traffic lights show green when the laser hits the detector.



Starts sequence for entering dimensions.

Measure and enter dimensions.



You must enter the distance between the sensors, and the distance between the center of the coupling and the M-sensor.



Go to measurement in cold condition.



Go to measurement in hot condition.

MEASUREMENT IN COLD CONDITION

Measurement point registration



Set the sensors at approximately the same rotational angle at the first measurement position, 9 o'clock. For best results, the rotational angles of the two sensors should be within 0.5° .



Touch the register icon.

This registers the first reading.

Rotate the turrets to the next position, 3 o'clock.



The green sector in the guide function indicates where the sensor should be positioned.



Touch the register icon.

This registers the second reading.



Touch the register icon.

This registers the third reading.

Rotate the turrets to the third position, 12 o'clock.

Measurement results



The Measurement Result screen shows coupling values for the measurement in cold condition.

The measurement result in cold condition can be saved separately.



Save the measurement result.

Once the cold condition has been measured, you can continue by measuring the hot condition, or open a previously saved measurement for the hot condition.



Go to hot condition.



Select a saved measurement for hot condition or measure the hot condition.

When both the cold condition and the hot condition have been measured, you can go to target values.



Go to target values.

It is also possible to re-measure the cold condition.



Re-measure cold condition.

MEASUREMENT IN HOT CONDITION

Measurement point registration



Set the sensors at approximately the same rotational angle at the first measurement position, 9 o'clock. For best results, the rotational angles of the two sensors should be within 0.5° .



Touch the register icon.

This registers the first reading.

Rotate the turrets to the next position, 3 o'clock.



The green sector in the guide function indicates where the sensor should be positioned.



Touch the register icon.
This registers the second
reading.



Touch the register icon.
This registers the third
reading.

Rotate the turrets to the third position, 12 o'clock.

Measurement results



The Measurement result screen above shows the coupling values for the measurement in hot condition.

The measurement result in hot condition can be saved separately.



Save the measurement result.

Once the hot condition has been measured, you can continue by measuring the cold condition or open a previously saved measurement in the cold condition.



Go to cold condition.



Select a saved measurement in cold condition or measure the cold condition.

Once both the cold condition and the hot condition are measured you can go to target values.



Go to target values.

It is also possible to re-measure the hot condition.



Re-measure hot condition.

TARGET VALUES



The Measurement Result screen shows the target values.

Document the target values



Touch the save icon to save the target values.

Shaft Alignment



Go to shaft alignment by touching this icon.

Check or re-measure



Go back to measurement in cold or hot condition.

OTHER FEATURES

Guide functions

The guide functions can be deactivated and activated again.



Deactivate guide functions.



Activate guide functions.

TIP: Deactivate the guide function when vibration levels are high.

ADJUSTMENT OF THE BUILT-IN LASER

If the beam from the built-in laser diode is not aligned with the rotational axis of the turret, the laser must be adjusted using the following instruction.

1. Mount the fixture on a solid base or machine casing and firmly tighten all fixation screws.



2. Turn on the built-in laser in the turret, by rotating the laser units clockwise until it bottoms.
3. Aim the laser onto a target (a piece of paper or cardboard) at a distance of 3-5 m.



4. Make a mark on the spot where the laser beam hits the target.

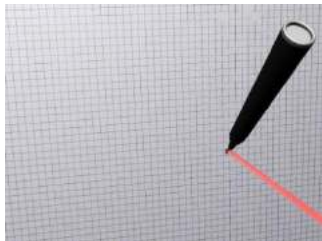

5. Rotate the turret 180°.



6. The laser spot should now have moved on the surface, in a pattern of a half circle.

Make a 2nd mark where the laser beam hits the target.

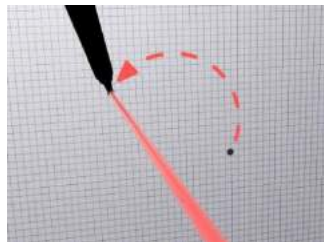

7. Make a 3rd mark on the target at half the distance between the 1st and 2nd mark.

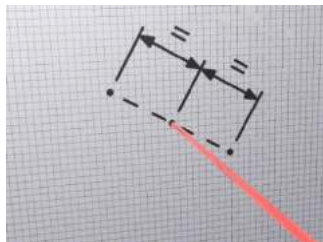

8. Adjust the position of the laser beam until it hits the 3rd marking on the target, using the two adjustment screws on the front on the turret. Make sure not to rotate the turret during the adjustment of the laser.



9. Control the alignment by rotating the turret 180° once again. The laser should now be at the same spot during rotation (within 2 mm).
10. Align the laser on the 2nd fixture as described in steps 1-8.

LASER POINTERS

Individually adapted

The laser pointers are individually adapted to their housings and should not be switched with each other.

Changing batteries

When the laser spot slowly starts to disappear, it is time to change the batteries.

Dismount the laser pointer from the turret and open the end cap of the laser device.

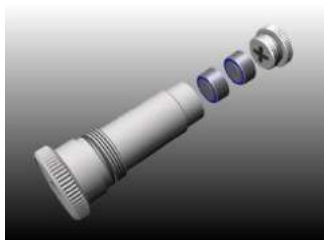

Use two SR44 batteries per device.
+ on the batteries must face the cap. (LR44 can also be used, but they only have approximately half the capacity of the SR44.)



HOT CHECK

INTRODUCTION

If you have un-explainable vibrations in your pump-motor installation, this application can help reduce your doubts (and your vibrations).

If you do not have the OL2R laser fixtures and do not have the possibility of measuring while the machine is running, it is still possible to check the thermal influences on the machine.

The Hot Check is performed by performing a measurement just after the machine has been shut off, and another measurement when the machine has been shut off so long

that it has reached ambient temperature. The Hot Check application is then used to compare these two measurements. The difference between the two measurements can be used as target values when shaft alignment is performed.



WARNING!

The machine must be shut off before starting the measurement.

MEASUREMENT METHOD

In the Hot Check program, a measurement in the cold condition is compared with a measurement in the hot condition to provide the target values.

The target values are calculated when the measurement result in the cold condition is subtracted from the measurement result in the hot condition.

The Horizontal Shaft Alignment program is used to measure these conditions. The measurement in hot condition is done just after the machine has been shut off. The measurement in cold condition is done when the machine is shut off and has dropped to the ambient temperature.

MEASURE HOT CONDITION

Shut off the machine.

Perform a measurement in the Horizontal Shaft Alignment program, just after the machine has been shut off. See the chapter “Shaft Alignment Horizontal Machines”.

Save this measurement.

MEASURE COLD CONDITION

Wait until the machine has dropped to the ambient temperature.

Perform another measurement in the Horizontal Shaft Alignment program. See the chapter “Shaft Alignment Horizontal Machines”.

Save this measurement.

STARTING THE PROGRAM



Start the program by touching the Hot Check icon in the Main Menu.

MAKING A HOT CHECK



Select a saved measurement in hot condition.



Select a saved measurement in cold condition.

Measurement in hot condition

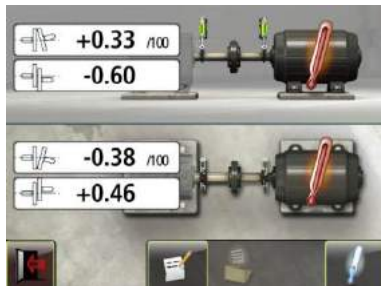

The Measurement Result screen shows coupling values for the measurement in hot condition.

Measurement in cold condition



The Measurement Result screen shows coupling values for the measurement in cold condition.

When both cold condition and hot condition values have been chosen, you can go to target values.



Go to target values.

TARGET VALUES



The Measurement Result screen shows the target values.

Document the Target Values



Touch the save icon to save the target values.

Shaft Alignment



Go to shaft alignment by touching this icon.



TARGET VALUES CLOCK

INTRODUCTION

Most machines develop a certain amount of heat while running. In the best case both the driving and the driven machine are affected equally requiring no input of compensation values. But in some applications the driven machine is either hotter, i.e. a pump for hot liquid, or cooler than the driving machine.

Machine manufacturers define the thermal expansion of machines differently, but in most cases, you will find it as a factor of deliberate misalignment expressed in parallel offset and angular error.

If the thermal expansion is defined as clock values, the Target Values Clock program can be used to translate clock values to angle and offset values.

The entered values are target values. Target values mean that these are the values at which the machine should be positioned when not running (cold condition) in order to obtain correct alignment while the machine is running (hot condition).

STARTING THE PROGRAM



Start the Target Values Clock program by touching the icon in the Main Menu.

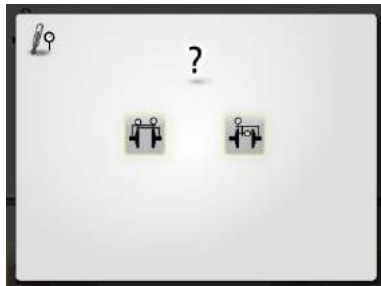

Select one of two ways to express the clock values: Reversed Rim or Rim Face.

REVERSED RIM

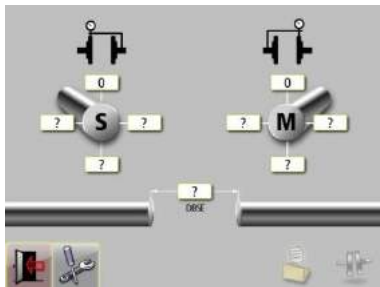

Touch the value boxes. Enter clock values in mm or mils according to the pre-set measurement unit together with the distance between shaft ends (DBSE).

The value at either 12 o'clock or 6 o'clock must be set to zero. 12 o'clock is preset to zero but if another value is entered at 12

o'clock, the value at 6 o'clock will be set to zero.

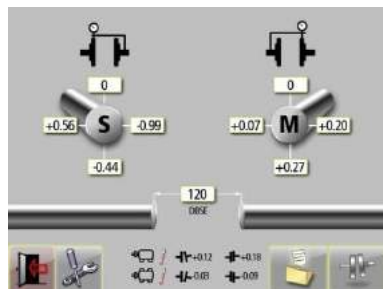

After having entered the required values, the system calculates how the movable machine should be positioned (target position) in cold condition in order to obtain perfect alignment during running condition. Calculated Target Values expressed as angle and offset values are shown in the bottom of the screen.

In the example above, the movable machine should be vertically adjusted to a position with an angular misalignment of +0.12 mm/100 mm and an offset of +0.18 mm.

Horizontally, the movable machine should be positioned with a -0.03 mm/100 mm angular misalignment and a -0.09 mm offset, in cold condition to obtain perfect alignment while running.

RIM FACE

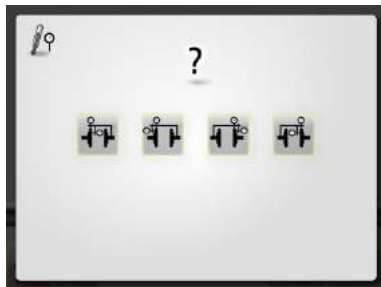

Select one of four ways to express the clock values in Rim Face.

S Front Face + S Radial

S Back Face + S Radial

M Back Face + M Radial

M Front Face + M Radial

An example with M Front Face + M Radial is shown here.

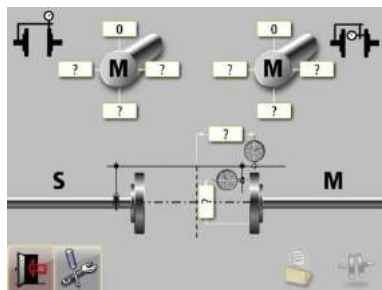

Touch the value boxes. Enter clock values in mm or mils according to the pre-set measurement unit together with the required distances.

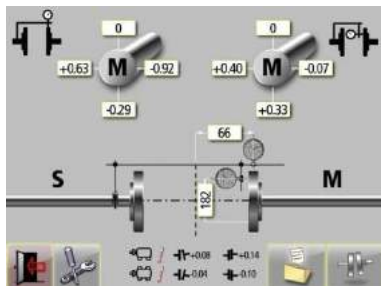

with an angular misalignment of $+0.08$ mm/100 mm and an offset of $+0.14$ mm.

Horizontally, the movable machine should be positioned with a -0.04 mm/100 mm angular misalignment and a -0.10 mm offset, in cold condition to obtain perfect alignment while running.

After having entered the required values, the system calculates how the movable machine should be positioned (target position) in cold condition in order to obtain perfect alignment during running condition. Calculated Target Values expressed as angle and offset values are shown in the bottom of the screen.

In the example above, the movable machine should be vertically adjusted to a position

DOCUMENT THE TARGET VALUES



Touch the save icon to save the target values.

Entered clock values and calculated Target Values expressed as angle and offset values will be saved.

SHAFT ALIGNMENT



Go to shaft alignment by touching this icon.

Calculated Target Values expressed as angle and offset values will be uploaded.



SENSOR DISPLAY

On the Sensor Display, the values from the connected sensor(s) are displayed. It is also possible to zero, record values to file etc.



Start the program by touching the Sensor Display icon in the Main Menu.



Go to Settings for selecting settings.

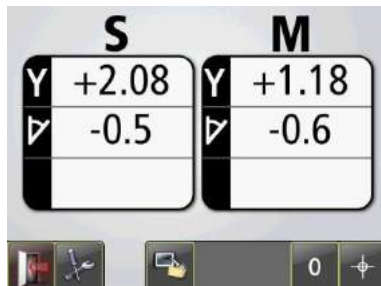

FUNCTIONS

When entering Sensor Display the raw data from the sensor(s) connected are displayed. If any value is missing, ----- is shown. There are extensive functions available, e.g. zeroing.

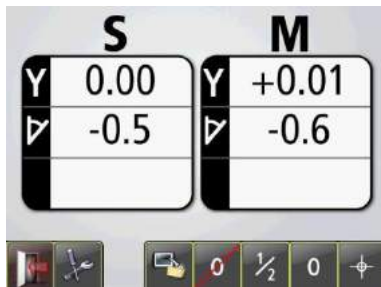

These are the functions available.



Record values to file.



Zero the values.



Halve the values (only available when Zero is active).



Reset values to raw data (only available when Zero is active).



Sample and display a single value.



Return to live values (only available when a value has been sampled).

Record values

This function allows you to record values that are sampled from the sensor(s) and store them in a file.

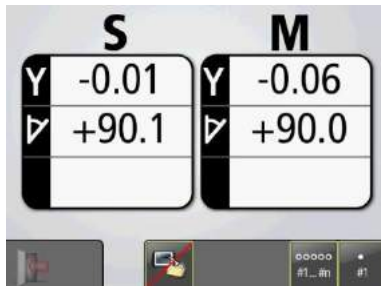

Start continuous recording (all values are recorded until the function is stopped).



Stop continuous recording (only available when continuously record is active).



Record single values.



Exit record values and return to live values.

Recording can be stopped and started several times and all the recorded values will be stored in the same file.

The recorded values are stored in a text file with a time stamp for each measurement.

NOTE: If record values are started when a single value has been sampled and displayed, only that value will be stored.



SENSOR DISPLAY LEVEL

INTRODUCTION

The Sensor Display for the Level sensor can be used to display, collect and store readings from the sensor in different ways for various applications.

It is possible to measure an objects angle towards gravity (levelling) or to measure an objects relative angular deviation (roll and pitch).

The Sensor Display program can show the values from the 2-axis sensor in both directions (α and β) as live values or it can record readings and present a fixed value for a measurement point. It is also possible

to download recorded measuring values or stream values to a data file.

MEASUREMENT METHOD

When measuring an objects angle towards gravity (levelling), the sensor is placed on the object and the displayed values are set to zero. Then, the sensor is rotated 180° and the displayed values are set to half. The shown values on the Sensor Display are the objects deviation towards gravity.

To measure the relative angle of an object, the sensor is placed on the object and the displayed values are set to zero. The object can then be moved, or the sensor can be placed on another object. The displayed values are the angular deviation relative to the first measuring point/object (zero).

STARTING THE PROGRAM



Start the Sensor Display Level program by touching its icon in the Main Menu.

FUNCTIONS

When entering Sensor Display Level, raw data from the connected Level sensor is displayed.

If any value is missing, ----- is shown.

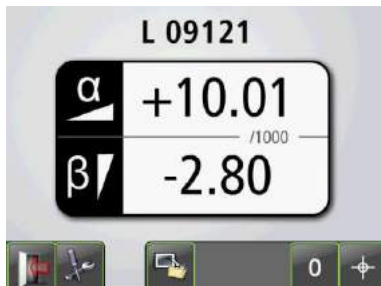

Wait about 20 seconds for the values to stabilize, before using any function.

Available functions at start



Zero values.



Sample and display a single value.



Record values to file.



Settings.



Home.

Zero values

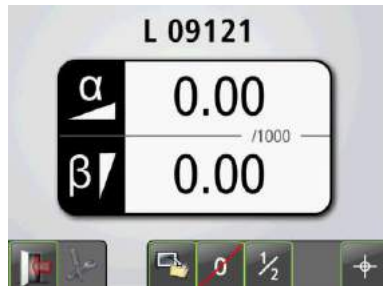

Sample and display a single value

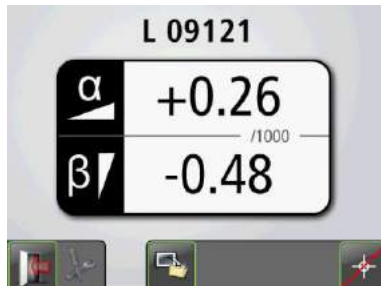

Halve values.



Reset values to raw data.



Return to live values.

Record values to file

Records values that are sampled from the sensor and stores them in a file.

Enter file name and confirm.



Record single values.



Start continuous recording.
(All values are recorded until the function is stopped.)



Stop and confirm continuous recording.
(Only available when continuous recording is active.)



Finish recording values to file.

Recording can be started and stopped several times and all the recorded values will be stored in the same file.

The recorded values are stored in a text file with a time stamp for each sampling.



SENSOR DISPLAY ROP

INTRODUCTION



The Sensor Display for the Run-Out Probe can be used for different applications where you want to use the readings from the linear sensor in various ways. The program is used with up to two sensors, P, connected to the display unit.

The Sensor Display program shows the values from both sensors. Each sensor is measuring the distance (d). The displayed values are shown live, or it can record readings and present a fixed value for a dedicated measurement point. The displayed measurement values can be zeroed to increase the usage in several applications. It is also possible to record measuring values or stream values to a data file.

MEASUREMENT METHOD

The Sensor Display program is used for general purposes in multiple applications. The displayed live values can be zeroed to measure the relative movement on a measuring object. If needed, the value from the probe can be recorded, where the display unit record values during a sampling time and presents a fixed value

When the Run-Out Probe is used to measure the position of an object to a rotational center, the values can be zeroed and then halved. Make sure that the Run-Out Probe is at a suitable part of the measuring range before zeroing.

STARTING THE PROGRAM



Start the Sensor Display ROP program by touching its icon in the Main Menu.

FUNCTIONS

When entering Sensor Display ROP, raw data from the connected Run-Out Probes are displayed.

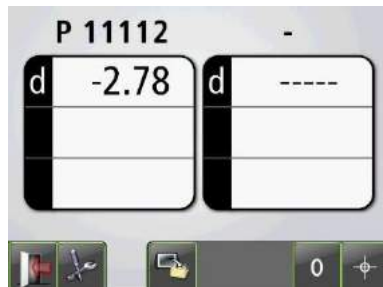

Available functions at start



Zero values.



Sample and display a single value.



Record values to file.



Settings.



Exit.

Zero values

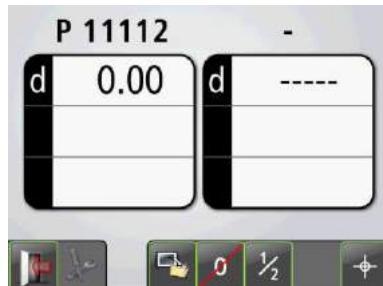

Halve values.



Reset values to raw data.

Sample and display a single value

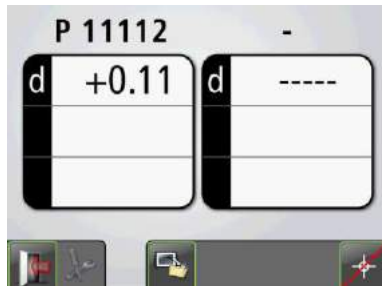

Return to live values.

Record values to file

Records values that are sampled from the sensors and stores them in a file.

Enter file name and confirm.



Record single values.



Start continuous recording.
(All values are recorded until the function is stopped.)



Stop and confirm continuous recording.
(Only available when continuous recording is active.)



Finish recording values to file.

Recording can be started and stopped several times and all the recorded values will be stored in the same file.

The recorded values are stored in a text file with a time stamp for each sampling.



MAX MIN ROP

INTRODUCTION

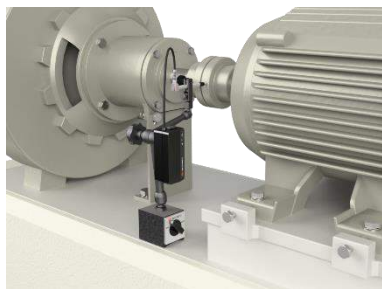

The Max Min ROP program for the Run-Out Probe can be used for several applications where the user wants to measure the displacement of an object to a rotational center.

A typical application is to measure run-out on a machine shaft or coupling hub. The Run-Out Probe is mounted in the desired measurement direction, radial or axial, and values are continuously recorded while rotating the object. Recording is done during a certain time, which can be set in the settings.

Result from the measurement are shown directly on the screen. The maximum value (Max) and the minimum value (Min) are shown together with the difference (Max-Min).

The measuring result can be saved and stored in the memory for further documentation.

MEASUREMENT METHOD

The method uses the measuring values from the Run-Out Probe. The Max Min ROP program continuously register values from the Run-Out Probe under a dedicated sampling time. The sampling time can be adjusted in the settings to allow recordings during at least one full revolution of the object.

The values from the Run-Out Probe can be zeroed before starting the max min measurement. Make sure that the Run-Out Probe is at a suitable part of the measuring range before zeroing.

When the recording is completed, the maximum value (Max) and the minimum value (Min) are shown on the screen together with the difference (Max-Min). The

results can be stored in the Memory Manager for documentation.

STARTING THE PROGRAM



Start the Max Min ROP program by touching its icon in the Main Menu.

RAW DATA

When entering Max Min ROP, raw data from the connected Run-Out Probes are displayed.

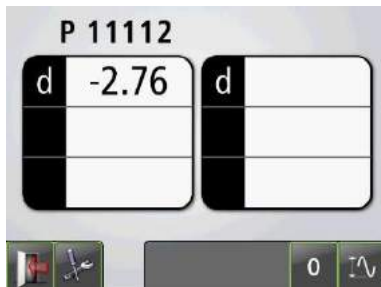

Adjust the position of the pen to be within the measuring range, using the raw data on the screen.



Zero values.



Measure max min.



Settings.



Exit.

ZERO VALUES

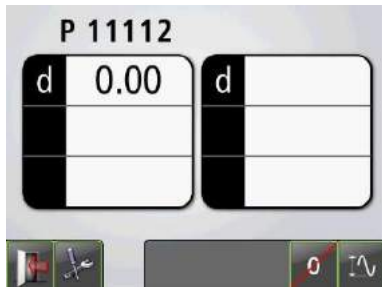

Measure max min.



Reset values to raw data.

MAX MIN

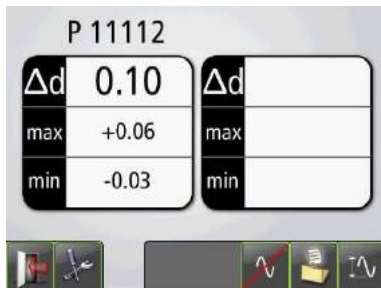

When max min is measured the difference during the measurement is displayed. The max and min values are also displayed.

The displayed measurement result can be saved.



Measure max min.



Save the measurement result.



Return to live values.

SETTINGS



The settings menu includes settings for Max Min.

Sampling time



Open window for sampling time settings.

Resolution shown



Opens window for selection of resolution shown.

Global Settings



Open Global Settings.

Confirm



Exits the Settings and returns to the application.



TEXT EDITOR

In the text editor, a text can be written, edited and saved separately.



Start the program by touching the Text Editor icon in the Main Menu.



Touch the text field to write or edit a text.



Save the text.



Erase all the text.



MACHINE DEFINED DATA

INTRODUCTION

If the sensors are placed at the same place each time a machine (or more identical machines) is measured, it can be convenient to preload the relevant parameters. The data that can be preloaded are:

- The name of the specific machine,
- Distances for the machine, the distance between the sensors (where fixture points are fixed), the distance between the center of the coupling and the M-sensor, the distance between the M-sensor and the first pair of feet and the

distance between the first and the second pairs of feet,

- Target Values as feet values or angle and offset values.
- Tolerances.

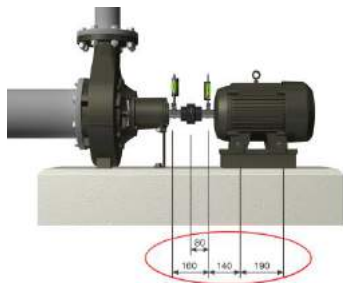



NOTE!

When using Machine Defined Data, the sensors must always be placed according to the preloaded distances to get correct measurement results.

STARTING THE PROGRAM



Start the program by touching the Machine Defined Data icon in the Main Menu.

USING MACHINE DEFINED DATA

OUTLAND		
<input type="checkbox"/>	RIGGOTV	2013-03-21 10:15
<input type="checkbox"/>	MACHINE 14	2013-03-20 11:41
<input type="checkbox"/>	RIGGO TV0	2013-03-19 16:23
<input type="checkbox"/>	M42	2013-03-19 13:22
<input type="checkbox"/>	M14	2013-03-12 18:12
<input type="checkbox"/>	M10	2013-03-06 17:57
<input type="checkbox"/>	RIGGO MM YTTRE	2013-02-19 17:02

A list of machine types with preloaded data is shown.

Select machine

Machines can be selected by touching its machine name.

This starts Shaft Alignment with machine defined data for the selected machine.

REPEATABILITY TEST

Before starting the measurement, it is recommended to perform a repeatability test to set the correct sampling time. With the correct sampling time, it is possible to reduce the influence of external conditions (e.g. air turbulence or vibrations) that otherwise would compromise the accuracy of the measuring result.

Perform the Repeatability Test at a position far away from the laser transmitter, if there are to be several measurement positions during a set of measurement.



The Repeatability Test function is accessed from the Sampling Time window.



The Repeatability Test takes 5 readings with the selected sampling time and shows the difference between highest and lowest value. This difference will decrease when selecting a longer sampling time.

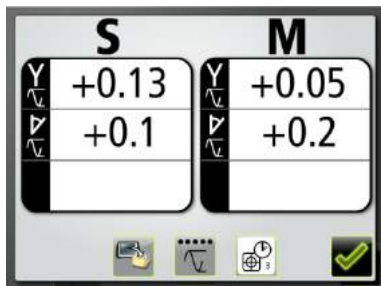

Adjust the sampling time and re-do the repeatability test until a satisfactory result is achieved.

Touch confirm and you will return to the sampling time with the latest sampling time tested.



Start Repeatability Test (i.e. take 5 readings and presents repeatability results).



Change Sampling Time.



Record repeatability test results to file.



Confirm and return to sampling time.

TOLERANCE TABLE

INTRODUCTION

Alignment tolerances depend to a large extent on the rotation speed of the shafts. Machine alignment should be carried out within the manufacturer's tolerances. The table provided in NXA can be helpful if no tolerances are specified. The suggested tolerances can be used as a starting point for developing in-house tolerances when the machinery manufacturer's recommended tolerances are not available. The tolerances are the maximum allowed deviation from desired values.



It is also possible to enter customized tolerances.

OPEN THE TOLERANCE TABLE

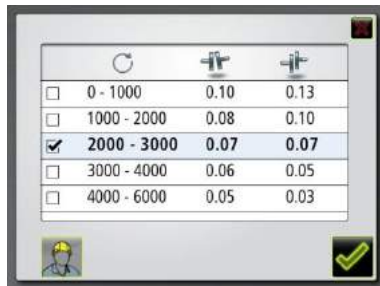

Open the Tolerance Table by touching this icon in Configuration.



			
<input type="checkbox"/>	0 - 1000	0.10	0.13
<input type="checkbox"/>	1000 - 2000	0.08	0.10
<input checked="" type="checkbox"/>	2000 - 3000	0.07	0.07
<input type="checkbox"/>	3000 - 4000	0.06	0.05
<input type="checkbox"/>	4000 - 6000	0.05	0.03

Tolerance Table mm-mode

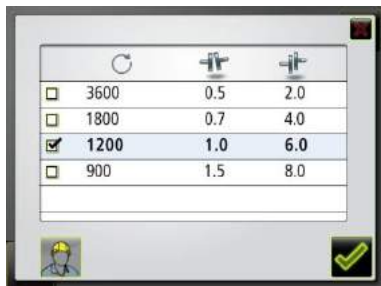

Tolerance Table inch-mode

SELECT TOLERANCE

- Select the tolerance to use in the alignment by touching its check box to the left.



Confirm

CUSTOMIZED TOLERANCES

Customized tolerances can be entered in the customized tolerance table.



Goes to customized tolerance table.

Enter customized tolerances by touching any of the fields, name/rotation speed to the left and tolerance values to the right.



Returns to standard tolerance table.



MEMORY MANAGER

EXPRESS MANAGER

Express Manager makes it easy to transfer files to a PC.

Insert a USB flash drive in the display unit while standing in the Main Menu and the Express Manager appears.





In the Express Manager measurements are sorted by date without folders.

Open file

Touch a file to open it.

Select files

 Touch the check box to the left to select a file.

 Touch the select all files icon to select all files.

Transfer files to USB flash drive

 Transfer selected files to USB flash drive.

Delete files

 Delete selected files.

STANDARD MANAGER

In the Standard Manager, all editing functions are available.

Open the Standard Manager from the Main Menu.



Measurements are sorted by date in folders.

Open file or folder

Touch a file or folder to open it.

Select files



Touch the check box to the left to select a file.



Deselect all files.

Cut, Copy and Paste



Cut selected items.



Copy selected items.



Paste items that have been cut or copied.

New folder



Create a new folder.

Change name of file or folder



Change name of selected file or folder.

Delete



Delete selected items.

PDF report



Generates a PDF report with the selected files.

Folder up



Go up one level in the file structure.

Exit



Exit the Standard Manager.

SAVE MEASUREMENT



When saving a measurement, both a text file and a picture file (jpeg) are created.

Enter file name

Touch the white field to enter a file name.

Confirm



Confirm.

TRANSFER FILES TO A PC

Files can be transferred to a PC using a USB flash drive.

Express Manager

Express Manager is the easiest way to transfer files to a PC. See “Express Manager”.

Standard Manager

Standard Manager can also be used to transfer files to a PC.

Insert the USB flash drive in the USB port of the display unit, and the USB flash drive will be available in the Standard Manager.

Files can be transferred to the USB flash drive with the cut/copy/paste functions in the Standard Manager.

The USB flash drive has to be open when pasting files.

Files in the PC

In the PC there will be two files for each measurement, a picture file (jpeg) and a text file. The picture file shows the same picture as in the memory. The text file shows just the measurement data.

PDF REPORT

A PDF report with several measurements from a folder in the Memory Manager can be generated.

Select files



- Touch the check box to the left to select files.

Generate a PDF report



Touch the PDF icon to generate a PDF report with the selected files.

Enter file name



Enter and confirm file name for the PDF report.

Enter data for the PDF report



Alignment Report

Report Date

Site

Machine

Operator

Comment

Touch the white field at the top to enter a header for the PDF report.

Touch the white fields to enter data.



Confirm data and generate PDF report

Transfer PDF file to a PC

The PDF file will appear in the folder where it was generated and can then be transferred to a PC.

PDF files cannot be opened in the display unit.

SHAFT ALIGNMENT HORIZONTAL MACHINES



The screen displays measurement results, dimensions, comment if any, target values if any, file name, date and time, serial number of the display unit and the sensors, program, program version and tolerances.

Add new Machine with Defined Data



Add new Machine with Defined Data.

Exit



Exit the measurement file.

Spacer Shaft



Saved Spacer Shaft measurement.

SHAFT ALIGNMENT VERTICAL MACHINES



The screen displays measurement results, dimensions, comment if any, file name, date and time, serial number of the display unit and the sensors, program, program version and tolerances.

It is possible to go to Shaft Alignment for vertical machines to continue measuring.

Any comment and dimensions that are not related to the positions of the sensors will be uploaded.

Go to Shaft Alignment



Go to Shaft Alignment for vertical machines.

Exit



Exit the measurement file.

SHAFT ALIGNMENT OFFSET MACHINES



The screen displays measurement results, dimensions, comment if any, file name, date and time, serial number of the display unit and the sensors, program, program version and tolerances.

It is possible to go to Shaft Alignment for vertical machines to continue measuring.

Any comment and dimensions that are not related to the positions of the sensors will be uploaded.

Go to Shaft Alignment



Go to Shaft Alignment for offset machines.

Exit



Exit the measurement file.

MACHINE TRAIN ALIGNMENT



The screen displays measurement results, dimensions, target values if any, file name, date and time, serial number of the display unit and the sensors, program, program version and tolerances.

It is possible to go to Machine Train Alignment to continue measuring. Any

comment, any target values and dimensions will be uploaded.



Change between viewing the coupling values and the feet values.



Minimum Moves (a reference based on the Minimum Moves function will be selected).



Select another reference.



Save changed measurement result.



Go to Machine Train Alignment.



Exit the measurement file.

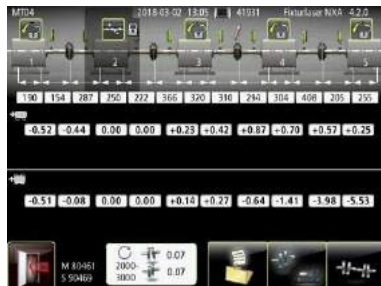

Feet value view.

SOFTCHECK



The screen displays measurement results, dimensions, file name, date and time, serial number of the display unit and the sensors, program and program version.

Exit



Exit the measurement file.

SOFTCHECK ROP



The screen displays measurement results, file name, date and time, serial number of the display unit and the Run-Out Probe, program and program version.

Exit



Exit the measurement file.

TARGET VALUES



The screen displays saved target values, any dimensions, file name, date and time, serial number of the display unit, program and program version.

It is possible to go to Shaft Alignment for horizontal machines to continue measuring. The target values, any comment and

dimensions that are not related to the positions of the sensors will be uploaded.

Go to Shaft Alignment



Go to Shaft Alignment for horizontal machines.

Exit



Exit the measurement file.

OL2R

Cold condition



The screen displays measurement results, file name, date and time, serial number of the display unit and the sensors, program and program version.

It is possible to go to OL2R for measuring in hot condition or to open a previously saved measurement in hot condition.



Go to OL2R (hot condition) by touching this icon.



Select a saved measurement in hot condition or measure in hot condition.



Exit the measurement file.

Hot condition



The screen displays measurement results, file name, date and time, serial number of the display unit and the sensors, program and program version.

It is possible to go to OL2R for measuring in cold condition or to open a previously saved measurement in cold condition.



Go to OL2R (cold condition) by touching this icon.



Select a saved measurement in cold condition or measure in cold condition.



Exit the measurement file.

TARGET VALUES CLOCK



The screen displays saved target values, any dimensions, file name, date and time, serial number of the display unit, program and program version.

It is possible to go to Shaft Alignment for horizontal machines to continue measuring. The target values, expressed as angle and offset values, will be uploaded.

Go to Shaft Alignment



Go to Shaft Alignment for horizontal machines.

Exit



Exit the measurement file.

MAX MIN ROP



The screen displays serial number of the Run-Out Probe, measurement results, file name, date and time, serial number of the display unit, program and program version.

Exit



Exit the measurement file.

TEXT EDITOR



Exit the measurement file.

The screen displays the saved text.

Touch the text field to write or edit a text.



Save the text.



Erase all the text.

GLOBAL SETTINGS



The global settings menu includes settings that are universal for all applications.

For most of the settings, the current selection is shown in the icon.

The program version number is also shown on this screen.

Date and time



Opens window for date and time settings.

Measurement unit

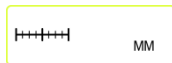

Changes between mm mode and inch mode.

Bluetooth settings



Opens window for Bluetooth settings.

Auto-start



Opens window for selecting automatic start of application program.

Battery status



Opens window for battery status information.

Backlight



Adjusts the backlight.

Service settings



Opens service settings. Requires access code.

BLUETOOTH SETTINGS

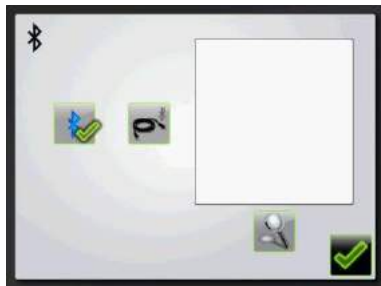

Communication mode



Activate Bluetooth



Deactivate Bluetooth and activate cable communication.

Pairing Bluetooth units

Touch the search icon to search for units that are pairable.



Search for Bluetooth units.

Pairable units will appear in the list to the right.

The wireless units must be switched on for the display unit to discover them. The display unit will only discover units approved by ACOEM.



- Touch the check box beside the units to pair.

Up to five units can be paired.*

*) In older display units (before 2015) up to three units.



Units that are paired to the display unit are marked with a check mark. The display unit **will only communicate with units that are paired and displayed in the list.**

If maximum number of units are paired to the display unit, some of them must be unpaired before it is possible to pair new units.

Unpairing Bluetooth units



Touch the check mark beside the unit to unpair.

Pairing cable units

Touch the search icon to search for units that are connected with cable.



Search for cable units.

Pairable units will appear in the list to the right.

The cable units must be switched on for the display unit to discover them. The display unit will only discover units approved by ACOEM.



Touch the check box beside the units to pair.

Maximum two cable units can be paired.

Units that are paired to the display unit are marked with a check mark. The display unit will only communicate with units that are paired and displayed in the list.

If maximum number of units are paired to the display unit, some of them must be unpaired before it is possible to pair new units.

Unpairing cable units



Touch the check mark beside the unit to unpair.

DISPLAY UNIT NXA D



1. 6.5" Touch screen
2. On button with status LED
 - a. Continuously green – ON

3. Battery Status button – press to instantly show the battery status when the unit is switched off.
4. Display Unit battery status
 - a. Continuously green – battery capacity
 - b. Rolling green – charging
 - c. First LED flashing red - <10% capacity
5. Measurement Unit battery status*

*) Will only work when the Display Unit is turned on and communicating with measurement units. If more than one measurement unit is used the LEDs will show the battery status of the measurement unit with the least charge.

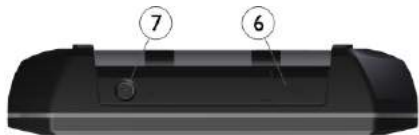

- 6. USB master (IP 67)
- 7. External power (IP 67)

OPERATING MODES

The display unit has two operating modes: On and Off.



To turn on the unit, press the ON button.



To turn off the unit, touch the Off icon in the main menu.

In case the system fails to respond, it is possible to turn it off by pressing down the ON button for more than 15 seconds.

CONNECTIONS

The main connection for the Display Unit is the built in Bluetooth connection. See chapter “Global settings” for instructions on how to pair measurement units.

In areas with restrictions on using wireless technology it is possible to use a custom cable available from ACOEM together with the USB master connection. Contact your local sales representative for more information.



NOTE!

Standard USB cables cannot be used to communicate with ACOEM measurement units.

See chapter “Global settings” for instructions on how to enable cabled operation.

The USB master can be used with USB flash drives to transfer files to a PC for storage.

POWER SUPPLY

NXA is powered by a high-capacity rechargeable Li-Ion pack in the display unit, or by the external power unit.

The operating time of the batteries is approximately 8-10 hours when the system is used for a typical alignment work (continually on with 50% backlight).

To prolong the operating time the backlighting of the screen should be used moderately.

If the system turns off due to low power, the resume function will save the data. When the system is turned on again after battery recharge or connection of external power, you will be prompted to choose whether to return to the state when the unit was turned off (i.e. resuming operation

without loss of data) or start the main menu.

The external power unit is connected to the external power connector on the display unit and to a wall socket with 110 - 240 Volts.

When the external power supply is connected, the unit will automatically start charging the batteries. This will be indicated by the battery status LED. The charging time is approximately 5-6 hours for fully drained batteries. The charging time will be longer if the unit is turned on while being charged.

When used in typical conditions the batteries will sustain good capacity for approximately 2-3 years before needing replacement. Contact your sales representative for battery re-placement.

The batteries contain safety circuitry to operate safely with the display unit. The unit can therefore only be used with the Li-Ion batteries supplied by ACOEM. Improper replacement of batteries can cause damage and risk for personal injury. Please refer to the chapter on safety for further instructions.

AUTO-OFF

In the Main Menu, the system will turn itself off automatically after 60 minutes inactivity.

SCREEN DUMP

A Screen Dump can be taken anywhere in the system, by pressing down the Battery Status button for more than 5 seconds.

Screen Dumps will be stored in the Measurements folder.

RESUME FUNCTION

If the system is turned off due to low power, the resume function will save the data.

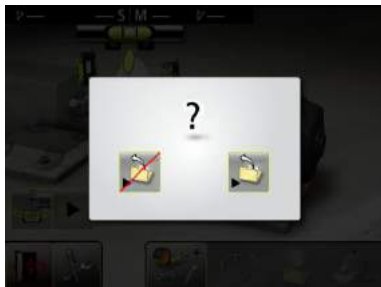

When the system is turned on again after charging the batteries, you will be prompted to choose whether to return to the stage when the system was turned off (i.e.

resuming operation without loss of data) or start the Main Menu.

UPGRADING THE SOFTWARE

Upgrades to the software will be sent out or made available for download on our website. The upgrade will be in a compressed zip-file, there is no need decompress it.

Put the zip-file on a USB stick. Insert the USB stick in the display unit. The upgrade file will be automatically detected by the software and the following screen will appear.



You can choose between exiting (and not upgrading) or installing the new software version. The version numbers of the existing and the new software are displayed above the icons.

To proceed with the installation, perform the following:

- Touch the upload new software icon.
- The box will turn itself off and reboot.

- The new software will be uploaded from the USB stick during the start up. This will take several minutes.

DO NOT REMOVE the USB stick during the installation.

- When the upgrade is finished the system starts the NXA application automatically.

DO NOT REMOVE the USB stick until the application has started up.

NOTE: If, after several minutes, the unit has not booted up and started the NXA application, please check if the light from the status LED on the USB stick is flashing or constant.

- If it is flashing files are being transferred - this is OK, wait until the display unit starts.
- If there is no flashing the display unit will need to be manually rebooted. Turn the unit off by pressing the on/off button for more than 15 seconds. Turn the unit on with a short press on the on/off button. Wait for several minutes until the display unit starts.

Settings and stored measurements will not be affected by an upgrade.

If you have a USB stick with another software version than the current inserted in the display unit, the upgrade window will appear every ten seconds. Remove the zip-file from the USB stick to prevent this.

FLASH

NXA software contains
Macromedia® Flash™ technology by Adobe
Systems, Inc.

Copyright© 1995-2003 Adobe Systems, Inc.
All rights reserved.

Adobe Systems, Flash, Macromedia Flash,
and Macromedia Flash Lite are trademarks
or registered trademarks of Adobe Systems,
Inc. in the United States and other
countries.

CALIBRATING THE TOUCH SCREEN

In order to make the touch screen to respond to the icons on the display, it may be necessary to recalibrate it from time to time.

Screen calibration procedure:

- Start the system.
- Wait until the main menu appears.
- Press down on the screen somewhere outside of the icons for 10 seconds.
- The screen calibration function should start.
- Touch and hold down on the target displayed until it moves.

- Repeat the step above on the 4 new positions of the target.
- When the target disappears, touch somewhere on the screen to finish and store the settings. (If, after the calibration procedure, you don't touch the screen to confirm within 30 seconds the calibration procedure will start again.)



NOTE!

For best results please use a stylus for calibration.

The calibration procedure will not work if you are using the auto-start function. Please turn this function off before restarting the display unit.

SENSORS M3 AND S3



1. ON/OFF button with status indication LED
 - a. Continuously green – On
 - b. Switching green/red – Gyro activated.
2. Mini USB for charging
3. Laser transmission indication LED
 - a. Green – laser transmission
4. Bluetooth indication LED
 - a. Continuously blue – paired and ready.
 - b. Flashing blue – searching/ready to pair
 - c. No light – Bluetooth disabled.



5. Battery status button – press to instantly show the battery status (also works when the unit is switched off).

6. Battery status LED
- One LED continuously red – less than 10% charge left.
 - One LED flashing red – less than 5% charge left.
 - One LED continuously orange – charging
 - One LED continuously green – fully charged.
7. Battery status LED when battery button is pressed
- Continuously green – battery status
 - Rolling green – battery charging

OPERATING MODES

M3 and S3 units has two operating modes:
On and Off.

Turn the units on and off by pressing the ON/OFF button firmly.

In case the units fail to respond, it is possible to turn it off by pressing down the ON button for more than 10 seconds.

CONNECTIONS

Bluetooth connection

The main connection for M3 and S3 units is the built in Bluetooth connection. The units will automatically connect to the display unit when turned on if they are paired. See chapter “Global settings” for instructions on how to pair measurement units to the display unit.

Cabled operation and enabling/disabling the Bluetooth transmission

In areas with restrictions on using wireless technology it is possible to use a custom cable available from ACOEM together with the mini USB connector. Contact your local sales representative for more information.



NOTE!

Standard USB cables cannot be used to communicate with ACOEM measurement units.

See chapter “Global settings” for instructions on how to enable cabled operation in the DU.

To avoid accidental Bluetooth transmission in a restricted area the Bluetooth function can be completely disabled – contact your local sales representative for more information.

If the Bluetooth has been disabled (as indicated by the fact that the Bluetooth LED is not flashing or continuously blue when the unit is turned on) it can be enabled by pressing the battery status button quickly 5 times in a row.

POWER SUPPLY

The M3 and S3 units are powered by a high-capacity rechargeable Li-Ion cell, or by the external power unit.

The operating time of the batteries is approximately 17 hours when the system is used for a typical alignment work (continuously on).

The M3 and S3 units can be charged with the supplied charger.

When the external power supply is connected, the unit will automatically start charging the batteries. This will be indicated by the first battery status LED turning orange, when the unit is fully charged the LED will turn green. By pressing the battery status button, the exact charging status can be monitored.

The charging time is approximately 8 hours for fully drained batteries. The charging time will be longer if the unit is turned on while being charged.

When used in typical conditions the batteries will sustain good capacity for approximately 2-3 years before needing replacement. Contact your sales representative for battery re-placement.

The batteries contain safety circuitry to operate safely with the unit. The unit can therefore only be used with the Li-Ion batteries supplied by ACOEM. Improper replacement of batteries can cause damage and risk for personal injury. Please refer to the chapter on safety for further instructions.

RUN-OUT PROBE PI

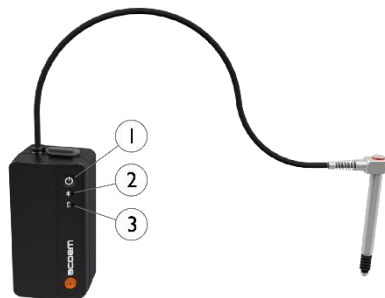

The Run-Out Probe is a battery operated, wireless linear gauge used for measuring run-out on shafts, coupling hubs, flanges and other components used on rotating machinery. It can also be used for distance measurements during adjustments of machinery, soft foot or checks of bearing clearances. The probe is wirelessly

connected to the display unit for registration, display and documentation of the measuring results.

1. ON/OFF button
2. Bluetooth indication LED
 - a. Continuously blue – paired and ready.
 - b. Flashing blue – searching/ready to pair
3. Battery status LED
 - a. Continuously red – less than 10% charge left.
 - b. Flashing red – less than 5% charge left.
 - c. Continuously orange – charging

- d. Continuously green – fully charged.

OPERATING MODES

PI units has two operating modes: On and Off.

Turn the units on and off by pressing the ON/OFF button firmly.

CONNECTIONS

Bluetooth connection

The main connection for PI units is the built in Bluetooth connection. The units will automatically connect to the display unit when turned on if they are paired. See chapter “Global settings” for instructions on how to pair measurement units to the display unit.

POWER SUPPLY

The PI units are powered by a high-capacity rechargeable Li-Ion cell, or by the external power unit.

The operating time of the batteries is approximately 11 hours (continuously on).

The PI units can be charged with the supplied combined charger.

When the external power supply is connected, the unit will automatically start charging the batteries. This will be indicated by the battery status LED turning orange, when the unit is fully charged the LED will turn green.

The charging time is approximately 8 hours for fully drained batteries. The charging time

will be longer if the unit is turned on while being charged.

When used in typical conditions the batteries will sustain good capacity for approximately 2-3 years before needing replacement. Contact your sales representative for battery re-placement.

The batteries contain safety circuitry to operate safely with the unit. The unit can therefore only be used with the Li-Ion batteries supplied by ACOEM. Improper replacement of batteries can cause damage and risk for personal injury. Please refer to the chapter on safety for further instructions.

LEVEL SENSOR LI



High precision 2-axes level sensor.

1. ON/OFF button with status indication LED
 - a. Continuously green – On
2. Mini USB for charging
3. Bluetooth indication LED
 - a. Continuously blue – paired and ready.
 - b. Flashing blue – searching/ready to pair
 - c. No light – Bluetooth disabled.

4. Battery status button – press to instantly show the battery status (also works when the unit is switched off).
5. Battery status LED
 - a. One LED flashing red – less than 10% charge left.
 - b. One LED double flashing red – less than 5% charge left.
 - c. One LED continuously orange – charging
 - d. One LED continuously green – fully charged.
6. Battery status LED when battery button is pressed
 - a. Continuously green – battery status
 - b. Rolling green – battery charging
7. Reference plane
8. Hole pattern for fixture
9. α reference



OPERATING MODES

LI has two operating modes: On and Off.

Turn the unit on and off by pressing the ON/OFF button firmly.

In case the units fail to respond, it is possible to turn it off by pressing down the ON button for more than 10 seconds.

CONNECTIONS

Bluetooth connection

The main connection for LI units is the built-in Bluetooth connection.

See Bluetooth settings in the chapter “Global Settings” for instructions on how to pair measurement units.

POWER SUPPLY

The LI unit is powered by a high-capacity rechargeable Li-Ion cell, or by the external power unit.

The operating time of the batteries is approximately 12 hours when the system is used for a typical measurement work (continuously on).

The LI unit can be charged with the supplied combined charger.

When the external power supply is connected, the unit will automatically start charging the batteries. This will be indicated by the first battery status LED turning orange, when the unit is fully charged the LED will turn green. By pressing the battery status button the exact charging status can be monitored.

The charging time is approximately 8 hours for fully drained batteries. (Charging to 50% takes approximately 2 hours.) The charging time will be longer if the unit is turned on while being charged.

When used in typical conditions the batteries will sustain good capacity for approximately 2-3 years before needing replacement. Contact your sales representative for battery re-placement.

The batteries contain safety circuitry to operate safely with the unit. The unit can therefore only be used with the Li-Ion batteries supplied by ACOEM. Improper replacement of batteries can cause damage and risk for personal injury. Please refer to the chapter on safety for further instructions.

AXES

LI measures the axes α and β .



HANDLING

Warm up the sensor for 30 minutes before starting the measurement.

Do not measure with external power connected.

MOUNTING

The LI sensor can either be placed on its reference plane or mounted on a magnet base.

Horizontal mounting on magnet base

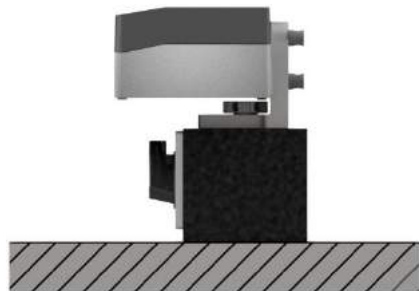

Vertical mounting on magnet base



TECHNICAL SPECIFICATION – NXA D

Art. No. I-0912

Housing Material	Brushed Anodized Aluminum frame and high impact ABS plastic over molded with TPE rubber
Operating Temp	-10 to 50°C (14 to 122°F)
Battery Charging Temp, system off	0 to 38°C (32 to 100°F)
Battery Charging Temp, system on	0 to 32°C (32 to 90°F)
Storage Temp	-20 to 70°C (-4 to 158°F)
Long term storage temp	Room temp. 18 to 28°C (64 to 82°F)
Relative humidity	10 – 90%
Weight	1,2 kg (2,6 lbs) with battery
Dimensions	224 mm x 158 mm x 49 mm (8,8 in x 6,2 in x 1,9 in)
Environmental protection	IP65 (Dust tight and protected against water jets)
Processor	1 GHz Dual core main processor with ultra-low power core for instant power management
RAM memory	256 Mb

Flash storage memory	8 Gb >100 000 measurements
Display	Colour Reality Display, TFT-LCD backlit, sunlight readable, with wide angle viewing technology
Display size	6,5" (165mm) diagonal (133 x 100 mm)
Display resolution	Full VGA 640x480 pixels
Colour depth	262 000 colours
Interface	6,5" High Impact Polyester laminated touch screen with enhanced transmission and reduced glare
Gyroscope	6-Axis MEMS Inertial Motion Sensor with drift compensation and automatic field calibration.
Connectors	USB 2.0 Master port (IP67) Power/Charger connector 10-14V DC (IP67)
Wireless communication	Class I Bluetooth transmitter with multi-drop capability
Power supply	High performance, High Temperature rechargeable Li-Ion battery or external power supply

Operating time	10 hours continuous use (with 50% LCD backlight)
Battery Charging time (system off, room temperature)	5 h
Battery Capacity	48.8 Wh
LED indicators	Unit state and 2x5 battery state indicators with instant battery check

Specifications are subject to change without notice.

TECHNICAL SPECIFICATION – M3 AND S3

Art. No. M3 I-0913, S3 I-0914

Housing Material	Anodized Aluminum frame and high impact ABS plastic over molded with TPE rubber
Operating Temp	-10 to 50°C (14 to 122°F)
Storage Temp	-20 to 70°C (-4 to 158°F)
Long term storage temp	Room temp. 18 to 28°C (64 to 82°F)
Battery Charging Temp	0 to 40°C (32 to 104°F)
Relative humidity	10 – 90%
Weight	192 g (6,8 oz) with battery
Dimensions	92 mm x 77 mm x 33 mm (3,6 in x 3,0 in x 1,3 in)
Environmental protection	IP65 (Dust tight and protected against water jets)
Laser	650 nm class II diode laser
Laser line fan angle	6°
Laser line width (1/e ²)	1.6 mm
Laser line divergence (full angle)	0.25 mrad
Laser power	< 1 mW
Measurement distance	Up to 10 m
Detector	2nd gen. scientific grade CCD

Detector length	30 mm (1.2 in)
Detector angular subtense	30 mrad/m (3mm/100mm per meter)
Detector resolution	1 μ m
Measurement accuracy	0,3% \pm 7 μ m
Signal processing	Digital signal processing with Sidespot rejection, edge detection, ambient light elimination and anti-vibration mode
Ambient light protection	Optical filtering and digital ambient light signal elimination
Inclinometer	Dual High Performance MEMS inclinometers
Inclinometer resolution	0,01 $^{\circ}$
Inclinometer accuracy	\pm 0,2 $^{\circ}$
Gyroscope	6-Axis MEMS Inertial Motion Sensor with drift compensation and automatic field calibration
Gyroscope accuracy	\pm 1 $^{\circ}$
Wireless communication	Class I Bluetooth transmitter
Communication range	10 m (33 ft)
Connectors	1 USB Mini port (IP67); Charging: 5V, 0.5A Communication: with separate USB/RS 485 adapter cable

Power supply	High performance Li Ion battery or external power.
Operating time	17 hours continuous use (measuring)
Battery Charging time (system off, room temperature)	8 h
Battery Capacity	10.4 Wh
LED indicators	Unit state, laser transmission and 5 battery status indicators with instant battery check

Specifications are subject to change without notice.

TECHNICAL SPECIFICATION – PI

Art. No. I-1063

Housing Material	ABS plastic
Operating Temp	0 to 40°C (32 to 104°F)
Storage Temp	-20 to 60°C (-4 to 140°F)
Long term storage temp	Room temp. 18 to 28°C (64 to 82°F)
Battery Charging Temp	0 to 40°C (32 to 104°F)
Relative humidity	10 – 90%
Weight	142 g (5.0 oz)
Dimensions battery unit	44 x 91 x 33 mm (1.7 x 3.6 x 1.3 in)
Dimensions pen body	Length: 85 mm (3.34 in) Diameter: Ø 8 mm (Ø 0.31 in)
Length cable	400 mm (15.7 in)
Environmental protection	IP65
Measuring range	5 mm (0.20 in)
Mechanical travel	6.6 mm (0.26 in)
Measuring force	0.70 N ±25%
Repeatability	0.15 µm
Thermal drift	0.25 µm/°C
Accuracy error (K=Reading in mm)	±MAX(5+ 2*K ; 7*K) µm

Contact type	Ø 3 mm (Ø 0.12 in) carbide
Contact thread	M2.5
Interface	Membrane Switch Keyboard
Wireless communication	Class I Bluetooth transceiver with multi-drop capability. BLE Bluetooth Low Energy (BT 4.0)
Communication range	10 m (33 ft)
Connectors	1 USB Mini micro port Charging: 5V, 0.5A
Power supply	Rechargeable Li Ion battery or external power supply.
Operating time	11 hours continuous use
Battery Charging time (system off, room temperature)	8 h
Battery Capacity	10.4 Wh
LED indicators	Wireless communication and battery status indicators.

Specifications are subject to change without notice.

TECHNICAL SPECIFICATION – LI

Art. No. I-1066

Housing material	Anodized Aluminum and ABS plastic
Operating temp	10 to 40°C (50 to 104°F)
Storage temp	-20 to 70°C (-4 to 158°F)
Battery charging temp	0 to 40°C (32 to 104°F)
Relative humidity	10 – 90%
Weight	386 g (13.6 oz)
Dimensions	77 mm x 84 mm x 45 mm (3.0 in x 3.3 in x 1.8 in)
Environmental protection	IP 65 (Dust tight and protected against water jets)
Inclinometer	High performance MEMS inclinometers
Calibrated measuring range	±50 mm/m
Displayed resolution	0.01 mm/m
Inclinometer accuracy	1% ± 0.01 mm/m
Temperature error	0.015 mm/m/°C
Stabilization time	18 s
Warming up time	30 min

Wireless communication	Class I Bluetooth transceiver with multi-drop capability. BLE Bluetooth Low Energy (BT 4.0) and Classic Bluetooth.
Communication range	10 m (33 ft)
Peripherals – User accessible	1 USB Mini port; Charging: 5V, 0.5A
Power supply	High performance Li Ion battery or external power.
Operating time	12 hours continuously
Battery charging time (system off, room temp)	8 h
Battery capacity	10.4 Wh
LED indicators	Unit state, battery status and Bluetooth status.

Specifications are subject to change without notice.



Publication No. P-0243-GB

© 2020 ACOEM AB, Mölndal, Sweden

All rights reserved. No part of this manual may be copied or reproduced in any form or by any means without prior permission from ACOEM AB.

www.fixturlaser.com